

YAMAHA®

AUTHORIZED PRODUCT MANUAL



DIGITAL PROGRAMMABLE ALGORITHM SYNTHESIZER

YAMAHA



DIGITAL PROGRAMMABLE ALGORITHM SYNTHESIZER
OWNER'S MANUAL

CONGRATULATIONS!

Your Yamaha DX27 Digital Programmable Algorithm Synthesizer incorporates state-of-the-art digital FM tone generation technology, providing extraordinarily vibrant, rich voices and outstanding playability. The DX27 has a programmable 24-voice INTERNAL memory (RAM) from which any voice can be selected at the touch of a button, two 96-voice PRESET ROM memories (a total of 192 fine preset voices!), a 96-voice BANK memory that permits storage of PRESET voices in any configuration for one-touch selection, and a cassette interface that permits unlimited storage of FM voices. Of course, the DX27 is fully programmable, allowing you to create your own FM voices or sound effects. Broad MIDI compatibility is also provided so the DX27 can control or be controlled via other MIDI-compatible music equipment.

To ensure that you gain maximum benefit from all the performance and flexibility provided by the DX27, we urge you to read this owner's manual thoroughly while actually trying out all of the available functions.

CONTENTS

CHAPTER 1: SETTING UP	3	CHAPTER IV: VOICE PROGRAMMING	25
1. Audio Outputs	3	1. The Basics of FM Synthesis	25
2. Optional Foot Switch	3	2. The EDIT and COMPARE modes	30
3. Optional BC-1 Breath Controller	3	3. The Voice Parameters	31
4. Headphones	3	4. STORING Voice Data	39
5. MIDI Terminals	3	5. Two Approaches to Creating Your Own Voices	39
6. Cassette	3	CHAPTER V: VOICE PROGRAMMING EXAMPLE	41
7. AC Power Adaptor	3	GENERAL SPECIFICATIONS	45
8. Music Stand Installation	4	MIDI DATA FORMAT	46
9. ID Function	4	1. Transmission Conditions	46
CHAPTER II: PLAYING THE DX27	6	2. Transmission Data	47
1. DX27 Voice Memory Configuration	6	3. Reception Conditions	50
2. The INTERNAL PLAY Mode	7	4. Reception Data	51
3. The BANK PLAY Mode	8	5. System Exclusive Data	54
The SHIFT Mode	8	VOICE/FUNCTION DATA	58
4. The 192-Voice PRESET Memory	9	DATA NAME	59
PRESET SEARCH	10		
CHAPTER III: THE FUNCTION MODE	11		
1. Accessing the FUNCTION Mode	11		
2. Entering Function Data	11		
3. The Performance Parameters	11		
4. Tuning Functions	17		
5. Memory Management Functions	17		
6. MIDI Functions	22		

PRECAUTIONS

1. Location

Avoid locations exposed to direct sunlight or other sources of heat. Also avoid locations subject to vibration, excessive dust, cold or moisture.

2. Cleaning

Do not attempt to clean the exterior with chemical solvents, as this may damage the finish. Clean with a soft, dry cloth.

3. Service and Modifications

Do not open the cabinet or attempt to make your own repairs or modifications to any part of the instrument. Such actions may not only result in electrical shock or damage, but will also void the product warranty. Refer all servicing to a qualified Yamaha service center.

4. Relocation

When moving the instrument be sure to unplug the AC mains cord as well as all other connecting cables.

5. Handling

Avoid applying excessive force to switches and slide controls, dropping or rough handling. The DX27 is ruggedly constructed using reliable solid-state circuitry, nonetheless it is a fine instrument that should be treated with care.

6. Electrical Storms (Lightning)

Digital circuitry such as that used in the DX27 is sensitive to voltage spikes and surges. Because of this, the DX27 should be turned off and unplugged from the AC power outlet in the event of an electrical storm.

7. Electromagnetic Fields

Digital circuitry is also sensitive to electromagnetic fields such as those produced by television sets, radio receivers, transmitters, transceivers, etc. The DX27 should be kept at least several feet from such sources in order to prevent possible random malfunctions.

CHAPTER I: SETTING UP

1. Audio Outputs

The DX27 has a single mono audio output for its tone generator channel. This is labelled OUTPUT. It permits sending a mono signal to either a mono or stereo sound system, or a mixing console for recording or PA applications.

2. Optional Foot Switch

The FOOT SW phone jack is for an optional footswitch. It accepts a Yamaha FC-4 or FC-5 footswitch or equivalent for portamento/sustain control: press for portamento or sustain; release to damp or turn portamento off.

3. Optional BC-1 Breath Controller

Yamaha's unique BC-1 breath controller is plugged into the mini-jack on the rear panel.

4. Headphones

The PHONES jack accepts any standard pair of stereo headphones. The audio signal is delivered to the headphones in mono. Headphone volume is controlled via the VOLUME control on the top panel.

5. MIDI Terminals

These terminals are used when connecting the DX27 to other MIDI (Musical Instrument Digital Interface) compatible equipment such as digital sequence recorders, modular FM voice generators, drum machines, etc. The MIDI OUT terminal transmits MIDI data from the DX27 to other MIDI equipment. The MIDI OUT terminal will normally be connected to the MIDI IN terminal of the receiving equipment. The MIDI IN terminal receives MIDI data from external MIDI equipment such as a digital sequence recorder, music computer or modular FM voice generator. The DX27's MIDI IN terminal will normally be connected to the MIDI OUT terminal of the transmitting equipment. The MIDI THRU terminal re-transmits the data received at the MIDI IN terminal. Thus, data received via the DX27 MIDI IN terminal can be simultaneously sent to other MIDI equipment.

6. Cassette

The DIN connector end of the supplied cassette cable is plugged into the DX27 CASSETTE connector. The three plugs on the other end of the cable should be connected to a cassette data recorder (the kind normally used with personal computers, etc.) as follows:

RED → cassette deck microphone input.

WHITE → cassette deck earphone output.

BLACK → cassette deck remote input (where applicable).

7. AC Power Adaptor

Insert the PA-1210 AC power adaptor (supplied standard) cord into the DC IN jack located on the rear panel of the DX27, and then plug the standard 2-prong plug into an AC wall socket. Be sure that your local line voltage matches that specified on the PA-1210. You will find the POWER switch next to the DC IN jack on the rear panel of the DX27.

DX27 CONNECTIONS

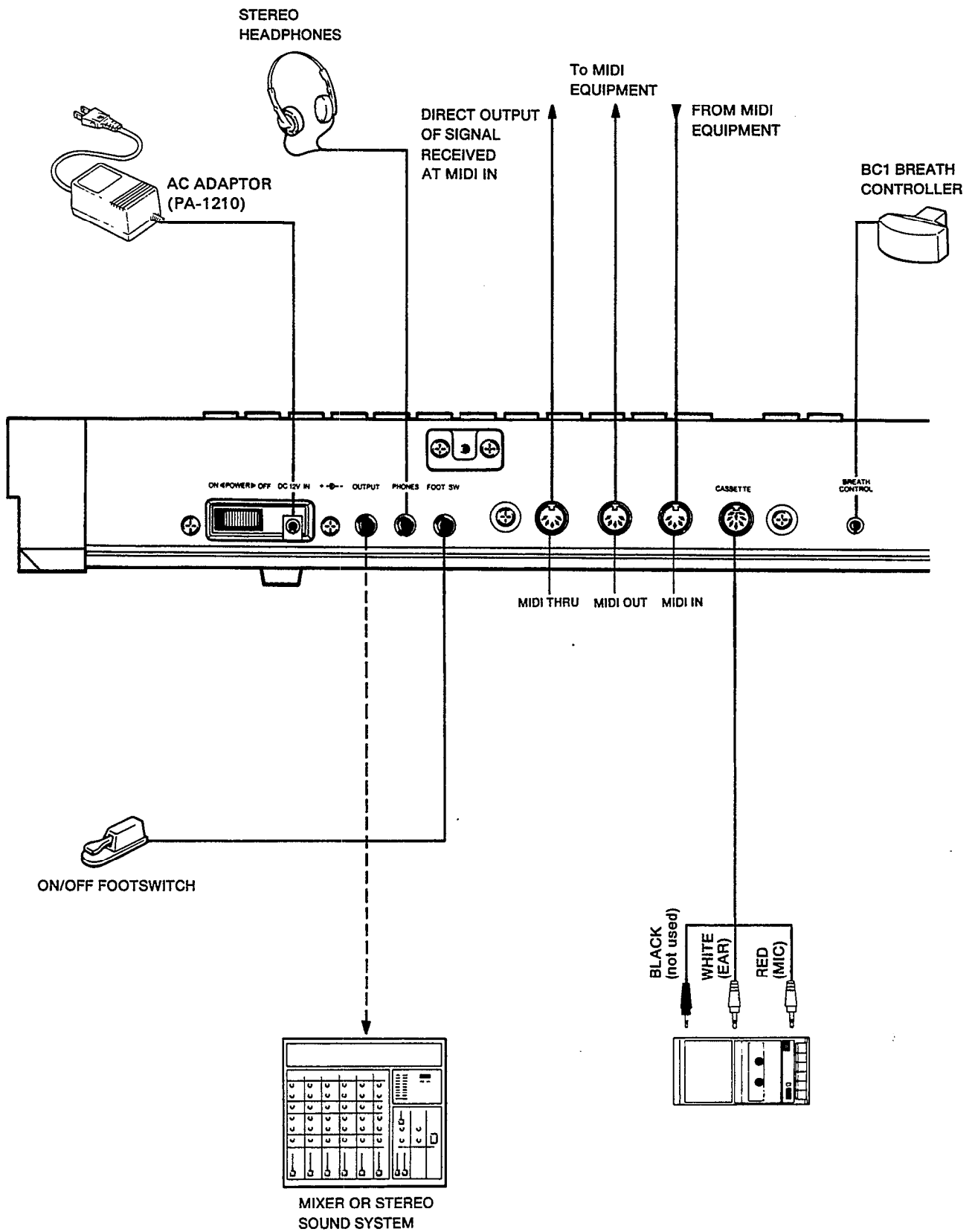

CHAPTER II: PLAYING THE DX27

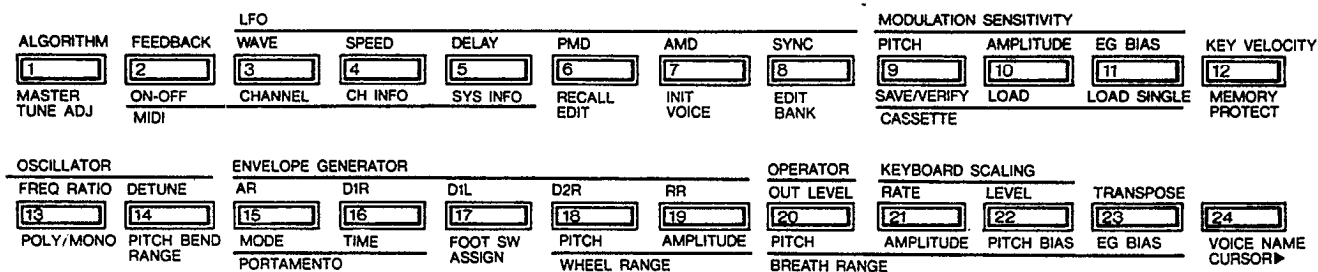
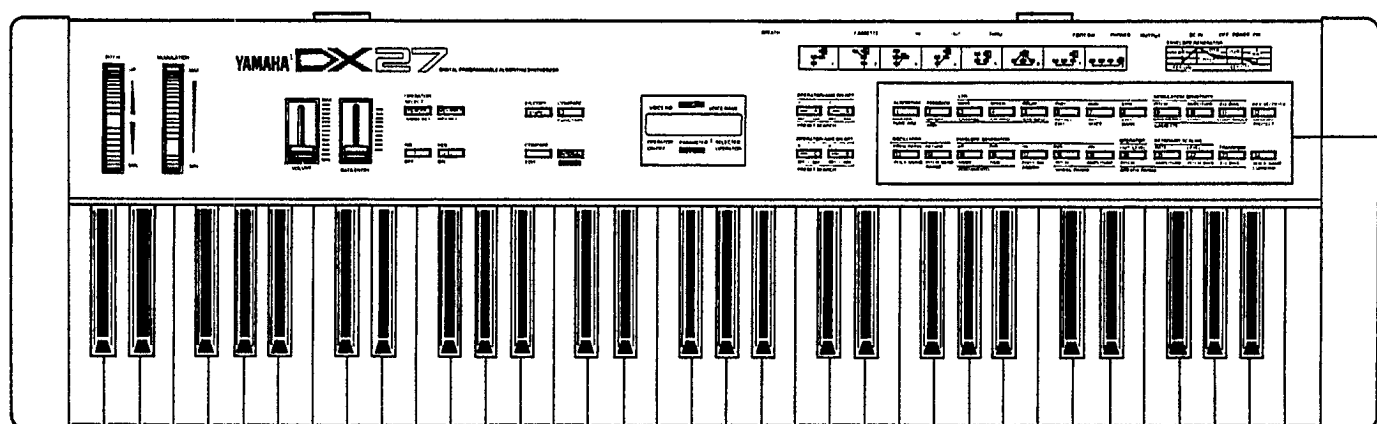

1. DX27 Voice Memory Configuration

The DX27 has three different voice memories which serve different purposes. They are:

The 24-voice INTERNAL memory

This voice memory is used for quick selection of voices for performance, and it is in this memory that original voices you have edited or programmed are initially stored. Cassette LOAD and STORE operations are also carried out to and from the 24-voice INTERNAL memory. Voices from the 192-voice PRESET memory may also be stored in the INTERNAL memory.

The 96-voice BANK memory (4 BANKS x 24 voices each)

The BANK memory incorporates four 24-voice BANKS-A, B, C and D. The BANK is most useful for storing groups of voices you have arranged for specific purposes. The different banks may be programmed with different voice groups you need for different "sets" in a performance, you can categorize your voices into BANKS (i.e. piano-type voices in one bank, brass in another, etc.), any combination you like. The BANK can be loaded with voices from the PRESET memory (described below) or from the INTERNAL memory using the EDIT BANK function.

The 192-voice PRESET memory

This is a read-only memory which contains 192 FM voices. These are organized into two groups of 96 voices each. The first group is accessible in the NORMAL

mode, while the second group is accessed in the SHIFT mode (these modes will be described below. These voices may be selected and stored in the BANK or INTERNAL memories as desired. They can also be directly accessed and played using the PRESET SEARCH function.

The chart below shows the overall DX27 voice memory configuration. The VOICE EDIT BUFFER is a special memory into which a voice is called when selected. Whether you select a voice from the INTERNAL memory, the BANK memory, or the PRESET memory, it is placed in the VOICE EDIT BUFFER from which it can be played, edited, stored in another memory location or saved onto cassette.

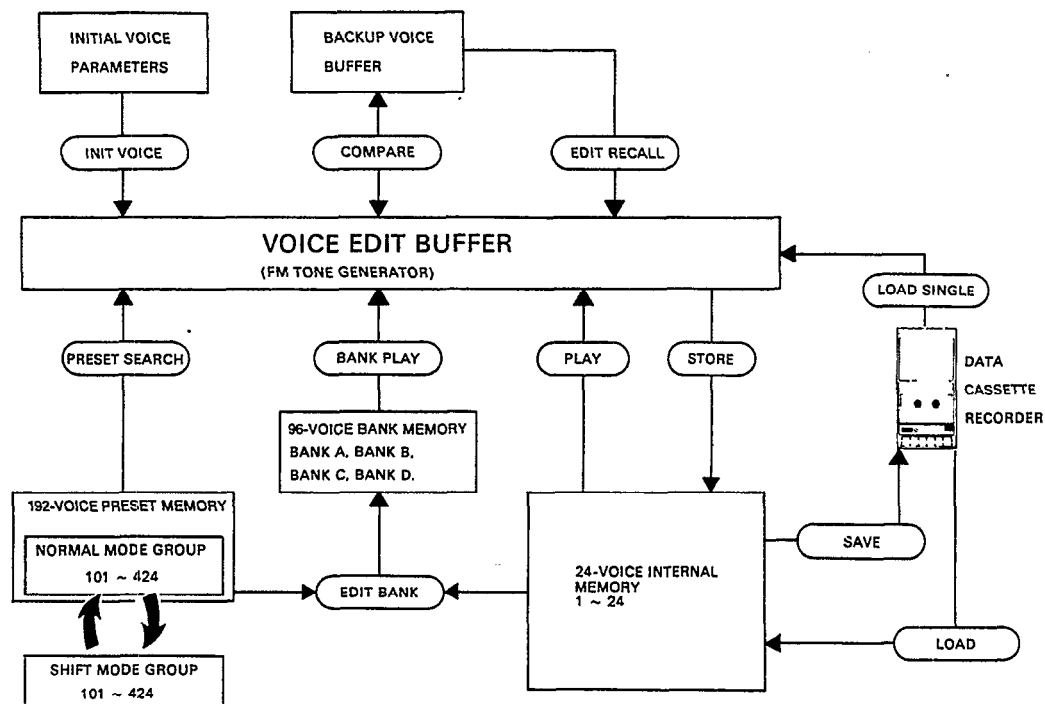

NOTE:

The voices in the PRESET memory are numbered as follows: each group of 96 voices-the NORMAL group and the SHIFT group-is further subdivided into four groups of 24 voices each (101-124, 201-224, 301-324, and 401-424). Thus you have NORMAL group voices 101-424, and SHIFT group voices 101-424.

2. The INTERNAL PLAY Mode

To access the 24-voice INTERNAL memory, enter the INTERNAL PLAY mode by pressing the INTERNAL PLAY button. Next, select a voice from the INTERNAL memory by pressing the corresponding voice selector button (1-24). At this point, the LCD display will indicate the voice number, and voice name. These are preceded by a "P," indicating that the INTERNAL PLAY mode has been selected.

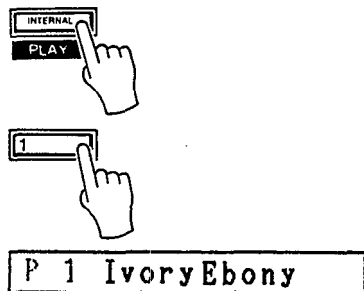

In this mode, you can play any of the voices currently in the DX27's 24-voice INTERNAL memory individually.

3. The **BANK PLAY** Mode

The BANK PLAY mode enables you to access the 96 BANK memory locations. These initially contain the first group of 96 voices from the 192-voice PRESET ROM. Using the SHIFT mode, however, you can also access the second group of presets while in the BANK PLAY mode. Later, you can store any voices you like in any order in these BANKS.

While in the INTERNAL PLAY mode, press any of the BANK buttons; BANK A-BANK D. This will select the appropriate BANK, and the 24 voices in that bank can be selected by pressing any of the DX27's 24 voice buttons.

PA 2 Uprt piano

The SHIFT Mode

By entering the DX27 SHIFT mode while in BANK PLAY, the correspondingly numbered voice from the second group (SHIFT group) of preset voices will be selected. Note that in the BANK PLAY mode this only applies to voices which have been stored in the BANK memory from the 192-voice PRESET memory. Voices stored in the BANK from the 24-voice INTERNAL memory will not change when the SHIFT mode is selected.

To enter the SHIFT mode, hold down the INTERNAL PLAY button and press the +1 button. To return to the NORMAL mode hold down the INTERNAL PLAY button and press the -1 button.

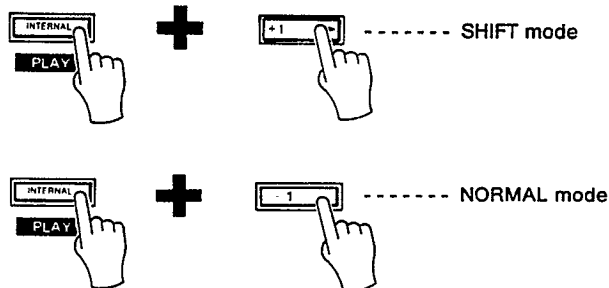

4. The 192-Voice PRESET Memory

The DX27 comes with 192 different pre-programmed voices in an internal ROM (Read Only Memory). These voices can be loaded singly into the DX27's selectable 24-voice memory, or into any location in the DX27 BANK memory.

THE 192 PRESET ROM VOICE NORMAL MODE VOICES

Group 1		Group 2		Group 3		Group 4	
01	IvoryEbony	01	Solid Bass	01	Easy Synth	01	Glocken
02	Uprt piano	02	SyntheBass	02	Easy Clav	02	Hamarimba
03	HonkeyTonk	03	Mono Bass	03	>>WOW<<	03	SteelDrums
04	Elec Grand	04	Elec Bass	04	Metal Keys	04	Tube Bells
05	Pianobells	05	Fretless	05	PickPluck	05	Templegong
06	Acous Elec	06	Horns	06	S/H Synth	06	Good Vibes
07	OldElectro	07	Flugelhorn	07	Heavysynth	07	Racing Car
08	NewElectro	08	Hard Brass	08	Harmosolo	08	Helicopter
09	High Tines	09	PowerBrass	09	Feed Lead	09	Alarm Call
10	Wood Piano	10	BC1Trumpet	10	Mono Lead	10	Dopplar ,FX
11	Vibrabelle	11	Strings	11	Lyrisynt	11	Storm Wind
12	Pianobrass	12	Silk Cello	12	Schmoooh	12	Birds
13	Jazz Organ	13	Orchestra	13	Claranette	13	Hole in 1
14	Ham<n>Eggs	14	SoloViolin	14	Pan Floom	14	<<Smash>>
15	Club Organ	15	Box Cello	15	Lead Reed	15	FM SQUARE
16	<6 Tease>	16	Richstring	16	Mono Sax	16	FM PULSE
17	GentlePipe	17	5th String	17	Flutewood	17	FMSAWTOOTH
18	Full Ranks	18	Harpsi low	18	<BC1> Sax	18	LFO NOISE
19	Plukguitar	19	Harpsi Hi	19	BC1 Hrmnca	19	PINK NOISE
20	Soft Harp	20	Fuzz Clav	20	Timpani	20	Windbells
21	Jazz Guit	21	Clear Clav	21	Xylosnare	21	Synvox
22	Old Banjo	22	Squeezebox	22	Synballs	22	Whistling
23	Kotokoto	23	Celeste	23	Clockwerks	23	Voices
24	Folk Guit	24	Circustime	24	HeiferBell	24	Mars to ??

SHIFT MODE VOICES

Group 1		Group 2		Group 3		Group 4	
01	Piano 1	01	Clickorgan	01	Rich Strg 1	01	Snare Bass
02	Piano 2	02	Drawbars	02	Rich Strg 2	02	SnareDrum 1
03	Piano 3	03	Guitar 2	03	Rich Strg 3	03	SnareDrum 2
04	Piano Vel	04	Fuzz Guit	04	Pizzicato	04	Tom Toms
05	Honkeyton 2	05	Brt Guitar	05	Harpsicrd 1	05	SteelDrum 2
06	Deep Grand	06	Zither	06	Harpsicrd 2	06	Synth Perc
07	PhaseGrand	07	Harp 1	07	Clav 1	07	Xylophone 1
08	Left Hand	08	Lute	08	Clav 2	08	Xylophone 2
09	Elec Grnd 2	09	Sitar	09	Mute Clav 1	09	Marimba
10	E Grnd Vel	10	SynthBass 1	10	Mute Clav 2	10	Mamarimba
11	E Piano 1	11	SynthBass 2	11	LeadSynth 1	11	Glocken 2
12	E Piano 2	12	Pluck Bass	12	Cheeky	12	Vibe
13	E Piano 3	13	Flap Bass	13	RubberBand	13	TublarBell
14	E P String	14	Uprt Bass	14	Hollowlead	14	BellsBells
15	Hard Tines	15	Brass 1	15	Huff Talk	15	Wild War !!
16	PercoPiano	16	Brass 2	16	Harmonica 1	16	YS 11
17	Organ 1	17	Brass 3	17	Harmonica 2	17	Wave
18	Organ 2	18	Brass 4	18	Horn	18	Winds
19	Elec organ	19	Brass 5	19	Flute 1	19	Shogakko
20	16 8 4 2 F	20	Brass 6	20	Flute 2	20	Fantasy
21	Theater	21	Brass 7	21	Oboe	21	SpaceChime
22	Small Pipe	22	Strings 1	22	Trombone	22	Ghosties
23	Mid Pipe	23	Strings 2	23	BC1 Horns	23	Space Talk
24	Big Pipe	24	Strings 3	24	Bassoon	24	Zing Plop

The PRESET voice can also be accessed directly and played using the PRESET SEARCH function.

PRESET SEARCH

This function allows you to directly access the voices in the PRESET memory, in the order they appear in the PRESET memory.

PRESET SEARCH is accessed in the FUNCTION mode. To enter the FUNCTION mode press the FUNCTION button. Then press any of the PRESET SEARCH selectors to access the corresponding voices (these are the same as the BANK A-D selectors used in the BANK PLAY mode). In the NORMAL (NON-SHIFT) mode, the PRESET SEARCH selectors call PRESET voice groups 101–124, 201–224, 301–324, and 401–424 from the NORMAL preset voice group. In the SHIFT mode (described in “The BANK PLAY Mode,” above), the correspondingly numbered voices from the SHIFT preset voice group are selected. The 24 voices in each group are selected by pressing the corresponding voice selector. After selecting PRESET SEARCH 101–124, for example, the LCD will appear as follows:

F301 Easy Synth

“F” indicates that you are in the FUNCTION mode PRESET SEARCH function.

This function lets you review the voices in the PRESET memory. It is also possible to store a voice selected in this mode into any of the 24-voice INTERNAL memory locations using the STORE function described later in this manual.

CHAPTER III: THE FUNCTION MODE

The FUNCTION mode permits access to four groups of functions: tuning functions, MIDI functions, memory management functions, and performance functions. In this chapter we'll describe each of these functions; what they do and how they are programmed.

1. Accessing the FUNCTION Mode

The FUNCTION mode is called by pressing the FUNCTION button. Individual parameters to be programmed are then called by pressing the appropriate voice button. Note that when the FUNCTION mode is active, pressing a voice button calls the corresponding FUNCTION parameter. These functions are printed in brown below each voice button. Note also that there are two exceptions: the PB (Pitch Bend) MODE SET and KEY SHIFT KEY SET buttons are NOT included among the voice buttons. These function buttons are located immediately above the DATA ENTRY -1 and +1 buttons. When the FUNCTION mode is called, the LCD should look something like this.

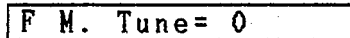

F M. Tune= 0

The display will read "FM.Tune= 0," indicating that the FUNCTION mode is active, plus the name of the selected function and its current data: In the example above, the MASTER TUNE function is called (press the 1 button), and the data is currently set at 0.

2. Entering Function Data

Once the desired function has been selected, its value can be altered using either the linear DATA ENTRY slider located to the left of the panel, or the adjacent -1/+1 buttons.

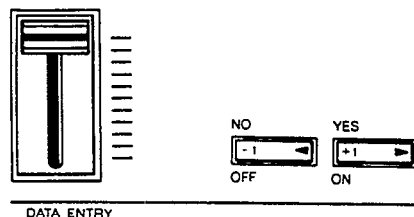

Moving the DATA ENTRY slider away from you increases the value of the selected parameter, and moving the control towards you decreases the data value. Pressing the -1 button decreases the value of the selected parameter by one (decrements), and pressing the +1 button increases the value by one (increments). While the DATA entry slider is valuable for quickly approaching the desired value with parameters that have a large data range, the +1 and -1 buttons permit precise step-wise location of a specific value. The switches are also easier to use with parameters that only have two values, i.e. ON (1) or OFF (0). In some cases you will be required to answer YES or NO to prompts which will appear on the LCD display. The -1/+1 buttons are also used for this purpose.

3. The Performance Parameters

"Performance parameters" are programmable parameters which pertain mainly to real-time performance effects, such as how the pitch bend and modulation wheels affect the sound. After a function is selected using the corresponding button, it can be incremented with further pressing of the same button.

* Note that performance parameters 13 through 24 can be individually stored for each voice. They must therefore be stored in the appropriate INTERNAL voice memory location after editing using the STORE function (see *CHAPTER IV: VOICE PROGRAMMING*, 4. Storing Voice Data).

13: POLY/MONO

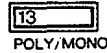

This function selects either the POLY or MONO note output mode. Voice programmed with the POLY mode permit simultaneous playing of up to 8 notes. In the MONO mode the DX27 acts as a monophonic keyboard.

Once the POLY/MONO function is selected, subsequent presses on the 13 button alternate between the POLY and MONO modes. The DATA ENTRY buttons can also be used: the -1 button selects POLY and the +1 button selects MONO.

14: PITCH BEND RANGE



This function sets the pitch range of the pitch bend wheel located to the left of the DX27 panel. The pitch bend wheel automatically centers at normal pitch. It then may be moved upward (away from the player) to raise the pitch, or moved downward (toward the player) to lower the pitch by the specified amount. The Pitch Bend direction can also be reversed: Hold down the PB MODE SET button while switching the DX27 power ON. This provides the same depth of effect, but in the opposite direction of wheel movement, which can be useful in performance situations.

The data range is from 0 to 12. At 0, the pitch bend wheel is off. Each increment between 1 and 12 represents a semitone, i.e. the pitch variation between any white key and a black key immediately next to it. Thus, if this function is set to 12, maximum travel of the pitch bend wheel either above or below center position produces a one-octave pitch variation.

The DATA ENTRY slider and -1/+1 buttons can be used to enter data. Once the PITCH BEND RANGE function is called, subsequent presses on the 14 button will increment (increase) the data value.

PB MODE: MODE SET



This function button, located immediately above the DATA ENTRY -1 button, offers a choice of three pitch bend wheel modes: Low, High and Kon. In the Low mode, the pitch bend wheel affects only the lowest note played on the keyboard. In other words, if a chord is played, the pitch bend wheel will affect only the pitch of the lowest note in the chord—this makes it possible to produce some interesting effects. The High mode is just the opposite, only the highest note played will be affected by the pitch bend wheel. In the Kon (Key on) mode, all notes played are affected simultaneously by the pitch bend wheel.

The DATA ENTRY slider and -1/+1 buttons or PB MODE button can be used to select the desired mode.

NOTE:

The PB MODE parameter is NOT individually programmable for each voice.

15: PORTAMENTO MODE

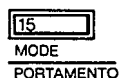

Two different portamento modes are available: Full Time Portamento and Fingered Portamento. When the POLY/MONO function is set to POLY (button 13), only the Full Time Portamento mode is accessible. In the MONO mode, you have a choice between the Full Time and Fingered portamento modes.

- (1) "Full T. Porta" (MONO and POLY modes): A conventional portamento effect in which portamento occurs whenever a new note is played.
- (2) "Fingered Porta" (MONO mode): Portamento only occurs if the previously played note is held while the next note is played. This mode is useful in recreating the effect of guitar string bending techniques, acoustic bass or bass guitar slide effects, etc. If you lift your hand off the DX27 keyboard between notes, there will be no portamento effect.

Once the PORTAMENTO MODE function is called, subsequent presses on the 15 button alternate between the two available portamento modes only if the MONO note output mode is selected. The DATA ENTRY or -1/+1 buttons can also be used to select the desired portamento mode.

16: PORTAMENTO TIME

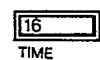

This function sets the speed of the portamento effect.

The data range is from 0 to 99. At 0, portamento is off. A setting of 99 produces the longest portamento effect.

Data can be entered using the DATA ENTRY slider and -1/+1 buttons. Once the PORTAMENTO TIME function has been called, subsequent presses on the 16 (PORTAMENTO TIME) button will increment the data value.

17: FOOT SWITCH ASSIGN



This function selects SUSTAIN or PORTAMENTO footswitch operation for the Yamaha FC-4 or FC-5 footswitch plugged into the rear-panel footswitch jack. Depending upon which of the two functions has been called via the 17 button (select using the -1/+1 buttons), the footswitch, when pressed, will operate correspondingly. When it is not pressed, the selected effect is OFF. The PORTAMENTO function parameters are adjustable via the PORTAMENTO MODE and PORTAMENTO TIME buttons (15 and 16, respectively). In the SUSTAIN mode, the footswitch will sustain notes played to the limit set by the ENVELOPE GENERATOR D2R parameter (see *CHAPTER IV: ENVELOPE GENERATOR*, 18: D2R) when it is set to a rate other than 0, even though the keys have been released. If the EG D2R is set to 0, then the D1L level will be maintained until the footswitch is released.

18: MODULATION WHEEL RANGE, PITCH



As you move the DX27 modulation wheel away from you, an increasing amount of LFO (Low Frequency Oscillator) modulation is applied to the selected voice. LFO modulation can be made to modulate the pitch of the voice, producing a range of vibrato type effects. This function is used to set the maximum depth of pitch modulation which can be applied using the modulation wheel. The actual effect produced depends on the settings of the LFO parameters, these will be discussed in *CHAPTER IV: VOICE PROGRAMMING*. Note, however, that the appropriate voice PITCH MODULATION SENSITIVITY parameter must be set to a value higher than 0 for pitch modulation to be effective. The voice PITCH MODULATION SENSITIVITY parameter will also be discussed in *CHAPTER IV*. The data range is from 0 to 99. At 0, pitch modulation is OFF, and rotating the modulation wheel will cause no pitch modulation to be applied to the voice. A setting of 99 produces the greatest possible pitch modulation depth.

Data is entered using the DATA ENTRY slider or buttons. Once this function is called, subsequent presses on the 18 button will increment the data value.

NOTE:

Modulation Wheel control direction is reversed simultaneously along with the Pitch Bend Wheel when the PB MODE SET button is pressed while turning on the power to the DX27.

19: MODULATION WHEEL RANGE, AMPLITUDE



As you move the DX27 modulation wheel away from you, an increasing amount of LFO modulation is applied to the selected voice. LFO modulation can be made to modulate the amplitude (level) of specified voice elements (operators), producing a range of tremolo or timbre modulation (wah-wah) type effects. This function is used to set the maximum depth of amplitude modulation that can be applied using the modulation wheel. The actual effect produced depends on the settings of the LFO parameters, these will be discussed in *CHAPTER IV: VOICE PROGRAMMING*. Note, however, that the appropriate voice AMPLITUDE MODULATION SENSITIVITY parameter must be set to a value higher than 0 for amplitude modulation to be effective. The voice AMPLITUDE MODULATION SENSITIVITY parameter will also be discussed in *CHAPTER IV*.

The data range is from 0 to 99. At 0, amplitude modulation is OFF, and rotating the modulation wheel will cause no amplitude modulation to be applied to the voice. A setting of 99 produces the greatest possible pitch modulation depth.

Data is entered using the DATA ENTRY slider or buttons. Once this function is called, subsequent presses on the 19 button will increment the data value.

The Yamaha Breath Controller

The optional Yamaha BC-1 breath controller is a unique way of adding musical expression as you play the DX27 keyboard. The BC-1 is held in the mouth just like the mouthpiece of a wind instrument. Blowing harder or softer into the BC-1 mouthpiece produces a corresponding effect. The breath controller can be used to apply varying amounts of pitch or amplitude LFO modulation, just like the modulation wheel. In addition, it can be set up to directly affect pitch, amplitude or timbre in response to breath pressure. Set to directly affect amplitude (EG BIAS), for example, the breath controller can be used to apply realistic tonguing effects to brass and other wind instrument sounds.

The four BREATH parameters listed below determine just how the breath controller will affect the DX27's sound. These parameters may be set individually, or combined for more complex effects.

20: BREATH RANGE, PITCH



This function is used to set the maximum depth of LFO pitch modulation that can be applied using the breath controller. The actual effect produced depends on the settings of the LFO parameters-these will be discussed in *CHAPTER IV: VOICE PROGRAMMING*. Note, however, that the appropriate voice PITCH MODULATION SENSITIVITY parameter must be set to a value higher than 0 for pitch modulation to be effective. The voice PITCH MODULATION SENSITIVITY parameter will be discussed in *CHAPTER IV: VOICE PROGRAMMING*.

The data range is from 0 to 99. At 0, pitch modulation is OFF, and applying breath pressure to the breath controller will cause no pitch modulation to be applied to the voice. A setting of 99 produces the greatest possible pitch modulation depth. Data is entered using the DATA ENTRY slider and -1/+1 buttons. Once this function is called, subsequent presses on the 20 button will increment the data value.

21: BREATH RANGE, AMPLITUDE



This function is used to set the maximum depth of LFO amplitude modulation that can be applied using the breath controller. The actual effect produced depends on the settings of the LFO parameters-these will be discussed in *CHAPTER IV: VOICE PROGRAMMING*. Note, however, that the appropriate voice AMPLITUDE MODULATION SENSITIVITY parameter must be set to a value higher than 0 for amplitude modulation to be effective. The voice AMPLITUDE MODULATION SENSITIVITY parameter will be discussed in *CHAPTER IV: VOICE PROGRAMMING*.

The data range is from 0 to 99. At 0, amplitude modulation is OFF, and applying breath pressure to the breath controller will cause no amplitude modulation to be applied to the voice. A setting of 99 produces the greatest possible pitch modulation depth.

Data is entered using the DATA ENTRY slider or -1/+1 buttons. Once this function is called, subsequent presses on the 21 button will increment the data value.

22: BREATH RANGE, PITCH BIAS

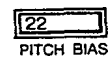

This function permits breath pressure applied to the BC-1 breath controller to directly control the pitch of the voice. In other words, the LFO has no effect. Only your breath pressure directly affects the pitch of the voice.

The data range is from 0 to 99. At 50, pitch bias is OFF. A setting of 99 permits a 4-octave pitch increase, and a setting of 0 permits a 4-octave pitch decrease to be produced through the breath controller.

Data is entered using the DATA ENTRY slider and -1/+1 buttons. Once this function is called, subsequent presses on the 22 button increment the data value.

23: BREATH RANGE, EG BIAS



This function permits breath pressure applied to the BC-1 breath controller to directly control the amplitude or timbre of the voice, according to settings of the corresponding voice parameters which will be covered in *CHAPTER IV*. The LFO has no effect-only your breath pressure directly affects the amplitude or timbre of the voice.

The data range is from 0 to 99. At 0, EG bias is OFF. A setting of 99 permits the greatest amplitude or timbre variation to be produced through the breath controller. Data is entered using the DATA ENTRY control and -1/+1 buttons. Once this function is called, subsequent presses on the 23 button increment the data value.

24: VOICE NAME



This function moves the LCD cursor from left to right, allowing you to name any new voice or sound you have created before storing it. When button 24 is pressed, the cursor flashes over the first letter in the name of the voice presently occupying a space in the INTERNAL memory. The DATA ENTRY slider or -1/+1 buttons are used to increment or decrement the alphabetical selection (A to Z), along with many other symbol selections, while subsequent presses on the VOICE NAME CURSOR button move the LCD cursor to the immediate right.

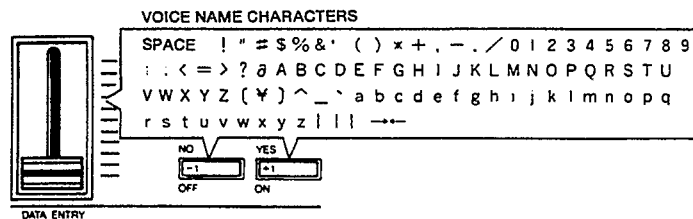

KEY SET



During either of the normal DX27 play modes, pressing the KEY SHIFT button instantly transposes the pitch of the entire DX27 keyboard up or down to a key programmed using this function. When KEY SHIFT is engaged, the letter "K" will appear at the left side of the LCD display until the KEY SHIFT button is pressed again, returning the keyboard to normal pitch.

Pressing this button in the FUNCTION mode permits a shift to the desired pitch when the KEY SHIFT button is pressed while in either of the play modes.

The transpose range for the KEY SHIFT function is plus or minus two octaves. The data range is from -24 to +24, with 0 corresponding to standard keyboard pitch. Each increment corresponds to a shift in pitch of one semitone—a setting of 2 would therefore raise the pitch of the entire keyboard a whole step.

Immediately after calling the KEY SET function, data can be entered simply by pressing a key on the keyboard within a plus/minus two-octave range of C3 (middle C). The pressed key then assumes the pitch of C3, and all other keys are adjusted accordingly. Pressing the A2 key, for example, produces a setting of -3. Pressing a key higher than C5 results in a +24 setting. This method of data entry, can only

be used once after this function is called. Subsequent changes must be made using the DATA ENTRY slider and -1/+1 buttons after the INTERNAL PLAY mode and KEY SHIFT function have been entered in succession.

NOTE:

The KEY SET function can not be individually programmed for each voice.

4. Tuning Functions

This section includes a single function: MASTER TUNE ADJ.

1: MASTER TUNE ADJ



This is the DX27 MASTER TUNE function. All voices are affected simultaneously. The programmable data range is from -64 to +63. When set to 0, the pitch of the A3 key is the standard 440 Hz. At the lowest setting of -64, the overall pitch of the keyboard is 100 cents (1 semitone) lower than standard pitch. At the highest setting of +63, the overall pitch of the keyboard is 100 cents higher than standard pitch.

Use the DATA ENTRY slider or -1/+1 buttons to enter the data for this parameter. Once the MASTER TUNE function is called, subsequent presses on the 1 button will increment the data value.

5. Memory Management Functions

The memory management functions include functions for loading voices from the DX27's 192-voice PRESET memory, for storing and loading the 24 INTERNAL memory voices to and from cassette tape, initializing the voice memory, recalling voice data from a special "safety" buffer memory, and turning the DX27 memory write/protect function ON and OFF.

6: RECALL EDIT



In addition to the voice edit buffer, the DX27 has a special edit recall buffer memory which maintains the last edited voice data. If, after editing or creating a new voice, you inadvertently call new data into the voice edit buffer by pressing one of the voice selector buttons before storing the edited voice data, the voice you had spent so much time editing will be erased from the edit buffer. If only one error of this type has been made, the edited data still resides in the backup voice buffer and can be recalled into the voice edit buffer using this function.

To do this, first press the FUNCTION button, then the RECALL EDIT button. The LCD will read "Recall Edit?" Confirm your intention to recall the data into the voice edit buffer by pressing the +1 button. The DX27 will again respond, this time with "Are you sure?" Press the +1 button again to actually execute the recall edit function. The EDIT mode will then be automatically entered, and the voice edit buffer will contain the data called from the backup voice buffer. Pressing another function button, the PLAY mode button or the EDIT mode button during the above process will abort the recall edit function.

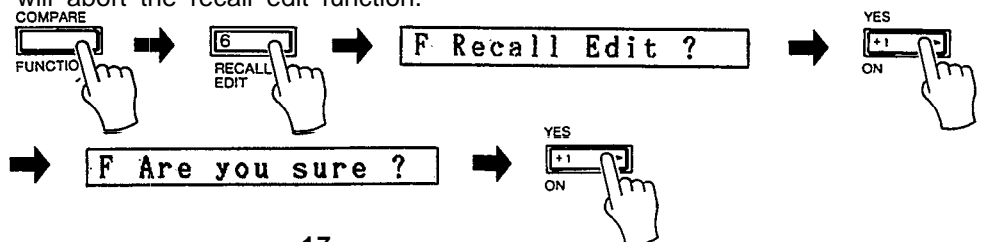

7: INIT VOICE



This function sets all voice parameters in the voice edit buffer to their “initialized” values, permitting voice programming from an effectively neutral set of values—a “clean slate.”

1	0	triang	35	0	0	0	off	6	0	0	0	0
ALGORITHM	FEEDBACK	WAVE	SPEED	DEDRY	LFQ	LANDS	SYNTH	SPICE	AMPLITUDE	RECT ENH	SECURE	

1.00	0	31	31	15	0	15	0	0	0	C3
1.00	0	31	31	15	0	15	0	0	0	
1.00	0	31	31	15	0	15	0	0	0	
1.00	0	31	31	15	0	15	90	0	0	
FREQ RATIO	DEPTH	ARR	DRY	DRY	DRY	DRY	DRY	DRY	DRY	
ADJUSTMENT	ADJUSTMENT	ADJUSTMENT	ADJUSTMENT	ADJUSTMENT	ADJUSTMENT	ADJUSTMENT	ADJUSTMENT	ADJUSTMENT	ADJUSTMENT	
Poly	4	Full T. Porta	0	Sus	50	0	0	0	50	0
DRY	DRY	DRY	DRY	DRY	DRY	DRY	DRY	DRY	DRY	

When this function is called, the LCD will read “Init. Voice?” Confirm your intention to initialize the voice edit buffer by pressing the +1 button. The DX27 will then ask you to reconfirm your intention to initialize the voice with “Are you sure ?” Press the +1 button again to actually execute the initialize operation. Once executed, the DX27 will automatically enter the EDIT mode, ready for voice programming. Pressing another function button, the PLAY mode button, or the EDIT mode button prior to the final step in the above process will abort the voice initialize function.

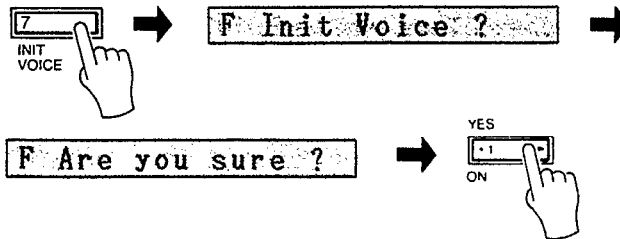

8: EDIT BANK



The EDIT BANK function allows you to load PRESET voices of the normal mode or shift mode and 24 INTERNAL memory voices into any of the 96 BANK memory locations, in the order you desire. In PRESET memory, they are immovable. If, for example, you want to have 10 specific voices all in consecutive memory locations

for convenience and ease of selection during a performance, you would use the EDIT BANK function to place your 10 required voices in locations 1—10 in BANK A.

There are 4 entire banks in the BANK memory. This means you can have 4 personally-arranged 24-voice groups to choose from, i.e., separate BANK for each set in a performance.

To enter the EDIT BANK function, press the FUNCTION button, followed by the EDIT BANK button. The LCD will respond with "Edit BANK?" Reaffirm your intention to complete the process by pressing the +1 button. The LCD will again respond, this time with "BANK? (A-D)." Select a BANK for editing, and in succession the button corresponding to the voice you want to change. Now, select a new voice for that position by using the DATA ENTRY slider or the -1/+1 buttons. Finally, you may select an additional voice to change, or press INTERNAL PLAY to exit the EDIT BANK function.

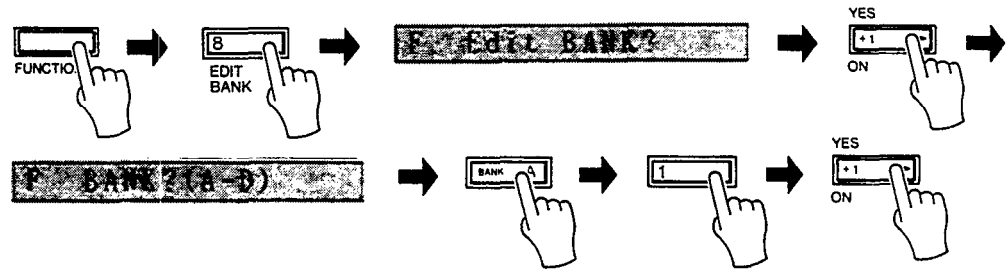

The following diagram shows approximately where in the DATA ENTRY control range the INTERNAL and PRESET voices are located.

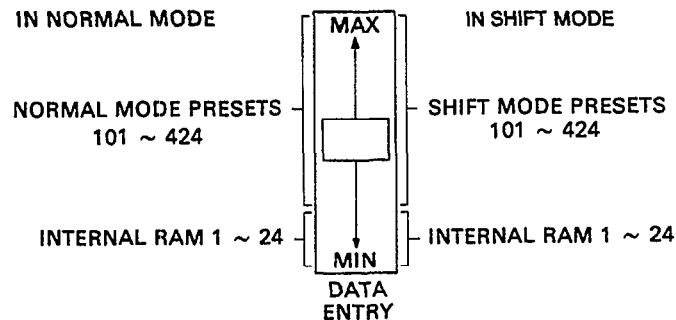

NOTE:

The BANK memories are not actually loaded with the voice data, but the voice number. Thus, when a BANK memory location is selected, the voice corresponding to the voice number stored in that location is called from its memory in either the INTERNAL or PRESET memories.

9: CASSETTE SAVE/VERIFY



This function actually incorporates two "sub-functions": SAVE and VERIFY. After calling this function, subsequent presses on the 9 button alternate between the SAVE and VERIFY sub-functions. Normally, however, you will start with the SAVE function, which saves the entire contents of the DX27's INTERNAL voice memory onto cassette tape. The VERIFY function is then used to check the saved data against the data still in INTERNAL memory, to ensure that no errors occurred in the SAVE process.

Before using this function, make sure that an appropriate data cassette recorder is properly connected to the DX27, as described in *CHAPTER I: SETTING UP*. When this function is initially called, the LCD will read "Save to Tape ?" Confirm your intention to save the contents of the 24 voices to cassette tape by pressing the +1 button. The display will then read "Save ready?" At this point, reconfirm that the cassette recorder is set up properly, make sure a suitable blank tape is loaded into the cassette recorder, and start the recorder running in the RECORD mode. To begin the actual save operation, press the +1 button. Pressing the -1 button prior to the final step in the above process will abort the CASSETTE SAVE function. As the DX27 saves each voice to tape, the LCD display will indicate the voice number being saved.

When all 24 voices have been saved, the DX27 will automatically go into the VERIFY mode, permitting you to check that the data was recorded properly.

Stop the cassette recorder. The LCD will now read "Verify Tape ?" To verify, first rewind the tape to the beginning of the file just saved, then press the +1 button in response to the "Verify Tape ?" display, which should be showing. The display will now read "Verify ready?" Press the +1 button, then start the cassette recorder running in the PLAY mode. The DX27 will now read each voice from the cassette tape, and compare it with the corresponding voice data in the INTERNAL voice memory, as the LCD indicates the verification process. If the cassette and INTERNAL data matches, the display will read "Verify Completed." Any PLAY mode can then be entered simply by pressing the corresponding mode selector button,

If an error is encountered, this will be displayed on the LCD. If this happens, go back and try the SAVE process—followed by the VERIFY process—one more time. If the error persists, then you may have to carefully adjust the record and/or playback level of the cassette recorder, or use a higher quality recorder or tape. Be sure to check that all cassette connections are made properly.

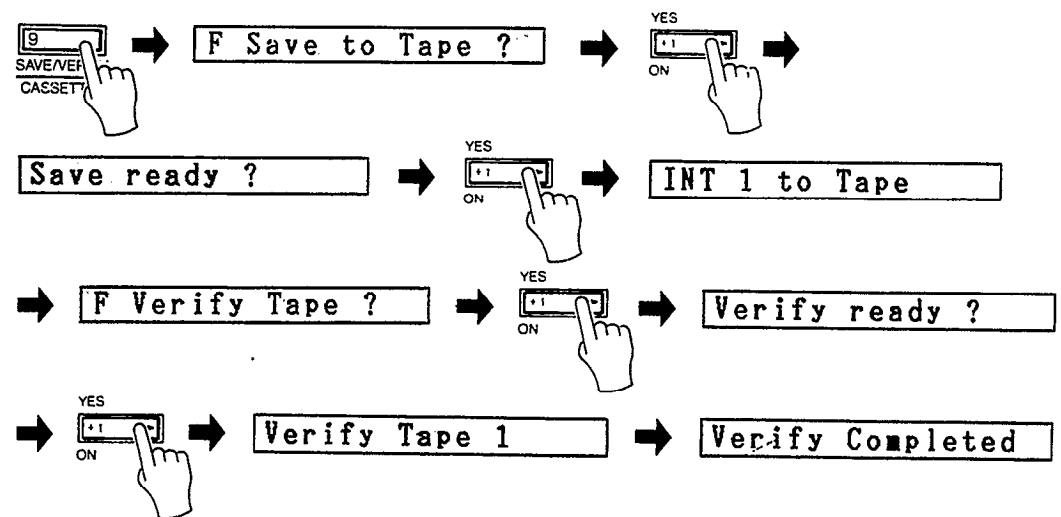

10: LOAD



This function loads a complete set of 24 voices from cassette tape into the DX27's INTERNAL voice memory. Before using this function make sure that all cassette connections have been properly made, as described in *CHAPTER I: SETTING UP*. Also make sure that the DX27's MEMORY PROTECT function (12) is OFF. When this function is initially called, the LCD will read "Load Tape ?" Confirm your intention to load a complete set of 24 voices from cassette tape into the RAM voice

memory (remember, this will erase any voices previously in the INTERNAL voice memory) by pressing the +1 button. The LCD will now read "Load all ready ?" At this point, make sure the appropriate cassette tape is loaded into the recorder and is rewound to the beginning of the desired voice file. To execute the load operation, press the DATA ENTRY YES button again and start the cassette recorder running in the PLAY mode. Pressing the -1 button prior to the final step in the above process will abort the CASSETTE LOAD function. The DX27 will indicate each voice on the LCD as it is loaded. When the load function is completed, the LCD will read "Load Completed."

Stop the cassette recorder and turn the DX27's MEMORY PROTECT function back ON. The LOAD function can be interrupted at any time by pressing the -1 button. This can, however, result in incomplete data loading, possibly causing "garbled" voice data to appear in one memory location.

NOTE:

Be sure to turn the MEMORY PROTECT function back ON after a successful LOAD operation.

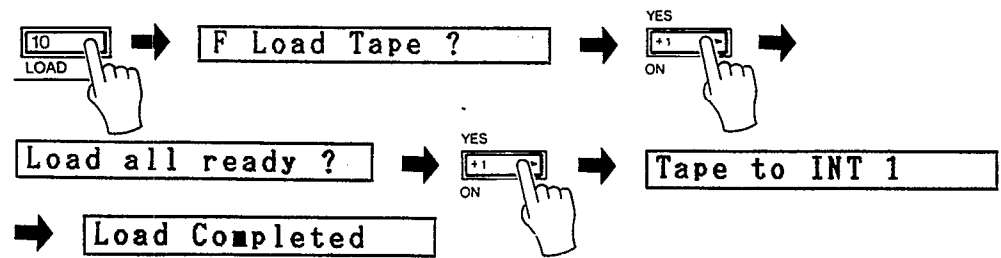

11: LOAD SINGLE

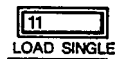

This function allows you to load a single voice from a previously saved 24-voice cassette file into the DX27's voice edit buffer, after which it can be stored in any voice location using the STORE function.

When this function is initially called, the LCD will read "Load Single ?" Press the +1 button to go on to the next step. The LCD will now read "Tape ?? to BUFF?" You must now enter the voice number of the voice you wish to load from cassette—do this by pressing the corresponding voice memory selector button. The selected voice number will appear in the LCD display. Then, make sure the appropriate cassette is loaded in the cassette recorder and is rewound to the beginning of the voice file containing the desired voice, press the +1 button, and start the cassette recorder running in the PLAY mode. The DX27 will automatically locate the selected voice and load it into the voice edit buffer, while the LCD reads "Search Tape," followed by the tape number. When finished, the display will read "Load Completed." The LOAD SINGLE function can be interrupted by pressing the -1 button. Doing this may, however, result in garbled voice data in the DX27's voice edit buffer.

The loaded voice may now be stored into any voice location by holding down the STORE button while pressing the voice button. This must be done before another voice button is pressed if you desire to keep the loaded voice in memory. Otherwise, the loaded voice data in the voice edit buffer will be erased and replaced by the voice data called by the pressed voice button.

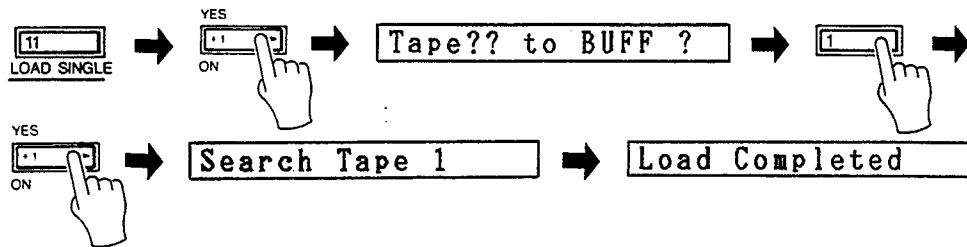

DX21 CASSETTE LOAD

NOTE:

If you have a voice set programmed on a Yamaha DX21 Digital Programmable Algorithm Synthesizer, these voices can be transferred from data cassette into the DX27. Of course, since the DX27 has 24 voice memories while the DX21 has 32, using the DX27 cassette LOAD operation will load only the first 24 voices of the DX21 32-voice set into the INTERNAL memory. The other voices (25-32) can be loaded using the DX27 LOAD SINGLE function. The voice numbers for voices 25 through 32 are accessed by pressing the STORE, FUNCTION, EDIT, INTERNAL PLAY, and BANK A-D buttons.

12: MEMORY PROTECT



This function turns the DX27 MEMORY PROTECT function on or off. When on, the INTERNAL voice memory cannot be altered using the STORE or CASSETTE LOAD functions. The MEMORY PROTECT function does not affect the voice edit buffer, so the INIT VOICE, RECALL EDIT, and CASSETTE LOAD SINGLE functions will operate whether MEMORY protect is on or off.

When this function is called, the LCD will read either "M. Protection" or "M. Protect:off," according to the current state of the MEMORY PROTECT function (MEMORY PROTECT is automatically turned ON each time main power to the DX27 is turned ON). The -1/+1 buttons and DATA ENTRY control are used to turn MEMORY PROTECT on or off.

6. MIDI Functions

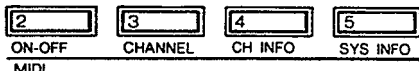

This group of functions deals with parameters which control the transmission and reception of MIDI data via the DX27's MIDI OUT and MIDI IN terminals. This section will describe how each parameter is programmed, while actual operational details will depend entirely on the type of MIDI equipment with which the DX27 will be used.

2: MIDI ON-OFF

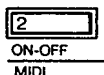

This function turns transmission and reception via the DX27's MIDI terminals on or off. When on, the DX27 can transmit or receive MIDI data to or from external MIDI equipment. When off, no MIDI data interchange is possible. This function is turned on or off using the -1/+1 buttons or DATA ENTRY slider.

3: CHANNEL



The DX27 is capable of receiving or transmitting data on any of the 16 available MIDI channels, or receiving in the OMNI mode which enables reception on all channels simultaneously. This function is used to set the desired MIDI receive or transmit channel or activate the OMNI receive mode. The receive or transmit channel is normally set to match the transmission or reception channel of the MIDI equipment to which the DX27 is connected.

Data is entered using the DATA ENTRY control or -1/+1 buttons. Subsequent presses on the CHANNEL button call the "Omni: on/off," "Midi R Ch=1—16," and "Midi T Ch=1—16" selection modes.

4: CH INFO



This is the MIDI channel information "button." It turns transmission and reception of all MIDI BASIC EVENT DATA and OTHER EVENT DATA (with the exceptions noted below) ON or OFF. This function is turned ON or OFF using the -1/+1 buttons.

Data transmitted and received whether this function is OFF or ON is:

- * KEY ON/OFF
- * SUSTAIN FOOTSWITCH ON/OFF
- * PITCH BEND WHEEL POSITION
- * MONO/POLY MODE SWITCH

Data received whether this function is ON or OFF is:

- * ALL NOTES OFF

Data NOT transmitted when this function is OFF is:

- * MODULATION WHEEL POSITION
- * BREATH CONTROLLER DATA
- * DATA ENTRY SLIDER AND SWITCH DATA
- * VOLUME (DATA ENTRY slider in PLAY mode)
- * PORTAMENTO FOOTSWITCH ON/OFF
- * PROGRAM CHANGE (VOICE NUMBER) DATA

Data not received when this function is OFF is:

- * All of the above
- * PORTAMENTO TIME

NOTE:

The above MIDI data is generally common to all keyboards and equipment compatible with the MIDI system. Due to differences in the features provided by some manufacturers, however, complete compatibility can not be guaranteed.

5: SYS INFO



This function turns transmission and reception of MIDI SYSTEM EXCLUSIVE INFORMATION data ON or OFF. The -1/+1 buttons are used to turn this function ON or OFF. When this function is ON, voice parameter changes made in the DX27's EDIT or FUNCTION modes are transmitted in real time.

If the SYS INFO button is pressed again, the "Midi Transmit?" display will appear. If the YES button is then pressed, then the DX27 will perform a bulk dump of all voice data—INTERNAL voices 1 through 24. Voices 25—32 will be dumped as INIT VOICE parameters.

CHAPTER IV: VOICE PROGRAMMING

1. The Basics of FM Synthesis

Before you begin actually programming or editing your own voices, a basic understanding of how digital FM synthesis works will be necessary. In the following explanation, we will learn how the DX27's FM voice generator produces complex voices. This information will help you to understand the process and make it easier for you to create and edit your own voices.

OPERATORS

The Yamaha DX series FM digital synthesizers use pure sine waves that interact to create the full harmonic spectrum for any voice. Each digital sine wave oscillator is combined with its own envelope generator to form an "operator."

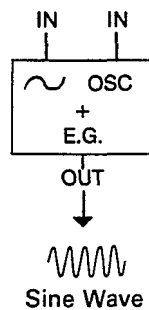

Note that the operator's oscillator has two inputs: one for the oscillator pitch data, and one for modulation data.

CARRIERS AND MODULATORS

The DX27 voice generator has 4 operators. When the output of one operator is fed to the modulation input of a second operator, i.e. the first operator modulates the second, a whole spectrum of harmonics is created that can form an incredibly diverse range of complex waveforms (including the more conventional triangle, sawtooth, and square waveforms). All this from just two operators!

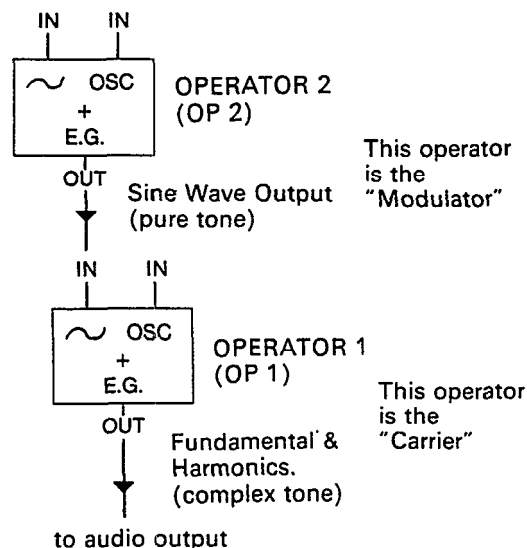

Operators do not have to be connected “vertically” in a modulator-carrier relationship, as shown above. The outputs of two operators can also be mixed-just as the stops in an organ are mixed. In this case the sounds are simply added together with no modulation effect.

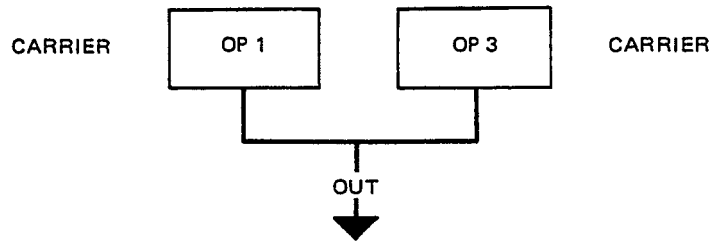

ALGORITHMS

We have seen two different ways that two operators may be combined. The DX27 uses four operators, offering many potential connection possibilities. These different configurations of operator relationships are called “algorithms,” and the DX27 offers 8 algorithm choices. These are all printed on top of the DX27 panel. In the algorithm diagrams on the panel, the small boxes numbered 1 through 4 are the operators.

ALGORITHM #1

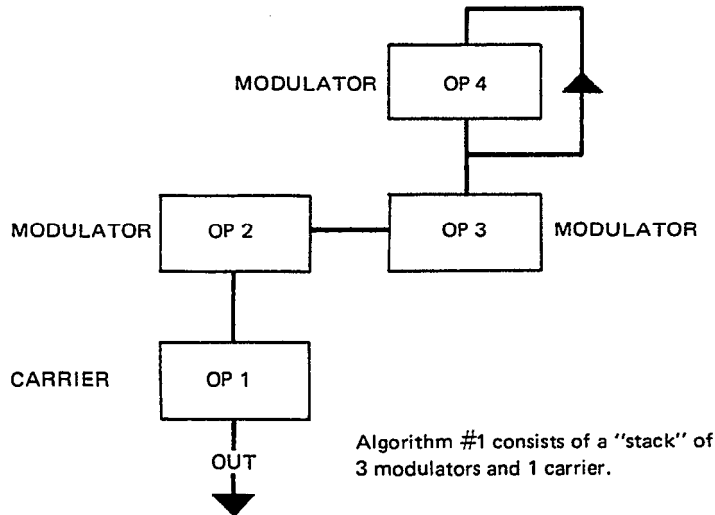

HOW ALGORITHMS AFFECT THE SOUND

By changing the relative frequencies between operators in a modulator-carrier relationship, you change not only the fundamental pitch of the note, but also the frequencies present in the harmonic structure. Thus, the timbre of the voice can be precisely controlled. In addition, since each operator has its own envelope generator (and a sophisticated one, too!), the harmonic structure of a note can be programmed to vary over time, just as a plucked string changes its overtones as the note decays.

Depending on the selected algorithm, operators can be stacked vertically, connected horizontally, or both. In the vertical arrangement, when the output of one operator is connected to the input of another the result is modulation. By convention, the operator at the bottom of a stack of operators is known as a “carrier.” All operators in the same stack above the carrier are “modulators.” By increasing the output level of one or more modulators feeding a carrier, the number of harmonics in the resultant sound is increased (its “bandwidth” is increased), making it more brilliant.

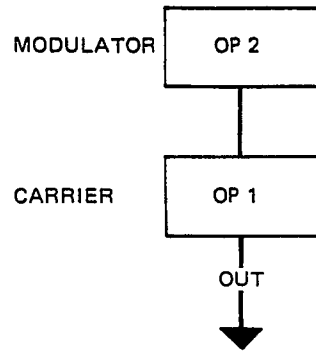

Most algorithms have multiple modulators and carriers. In one algorithm a given operator may be a carrier, while in the next it might function as a modulator—the only difference being how it is connected. In algorithm number 5 for example, there are two vertical stacks of two operators, and the outputs of the carriers in these stacks are connected in parallel (horizontally). Algorithm 5 has an equal number of modulators and carriers—two modulators and two carriers.

ALGORITHM #5

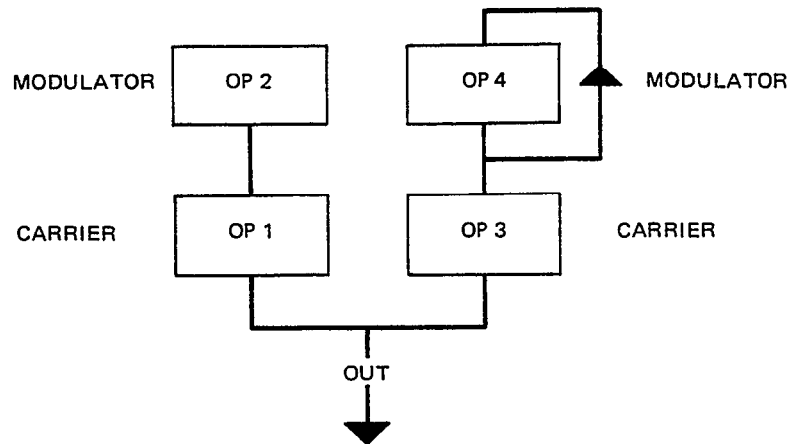

On the other hand, all operators in algorithm 8 function as carriers. Note that no modulation can occur in this algorithm (except for the feedback loop on operator 4—we'll discuss that later). But algorithm 8 is ideal for creating rich organ voices—think of each operator as different organ “stops,” which can be mixed together as desired.

The algorithm alone, however, does not determine the actual sound of the voice. The vital characteristics of the voice you create depend mostly on the frequencies and levels you program into each operator. The 8 algorithms provided in the DX27 were specially selected because they offer the broadest range of voice programming possibilities.

The results of using different frequency ratios, as well as different algorithms, are shown graphically in the accompanying illustration. In the left column, you see the waveforms created by 1:1, 2:1 and 3:1 ratios between one modulator and one carrier. In the right column, you see the waveforms which result from the same three ratios, but when the two operators used are both carriers (connected horizontally, this is known as additive synthesis).

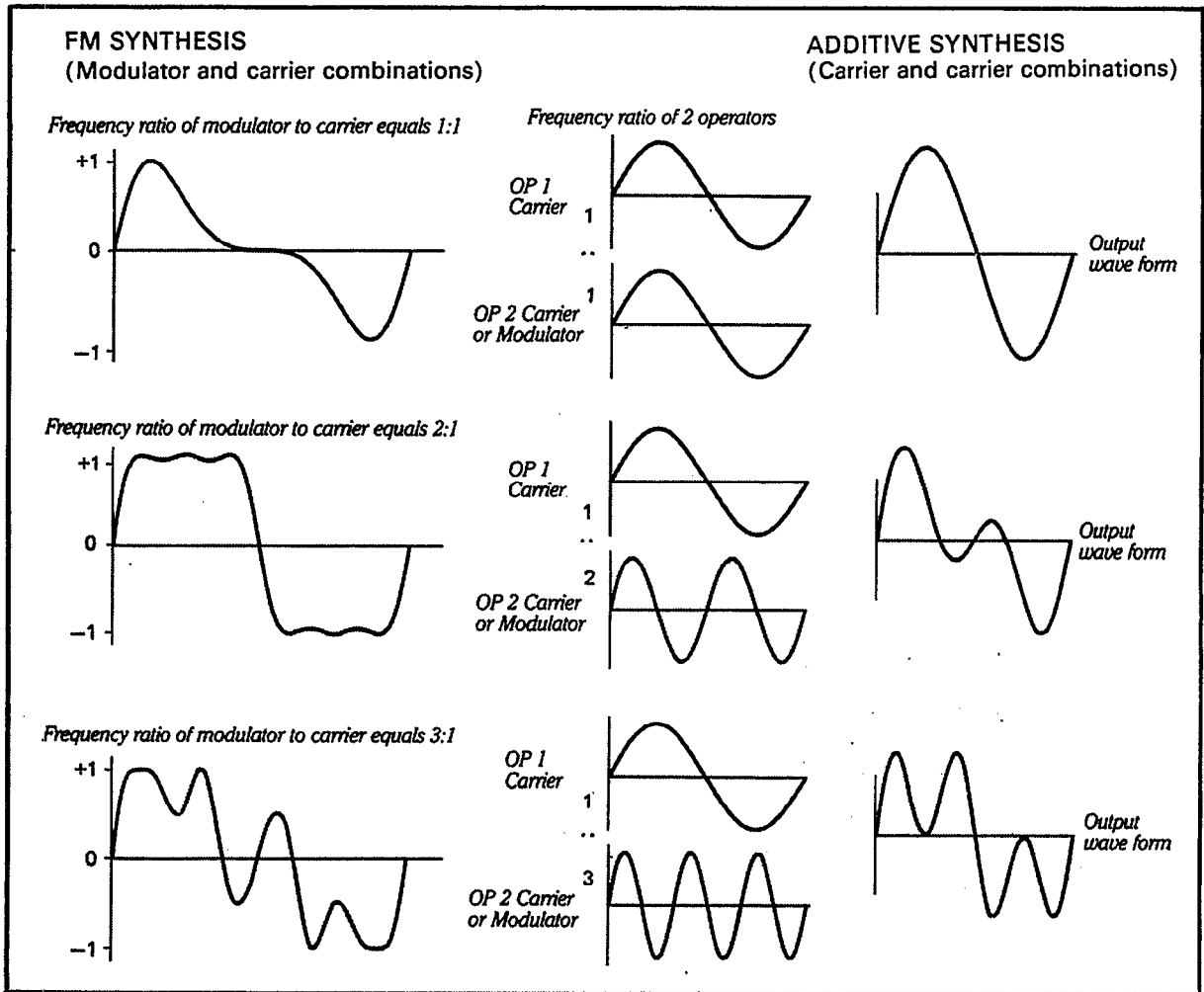

Still more variations can be achieved by changing the relative output levels between operators; the greater the level of the modulating operator, the more harmonics are present.

FEEDBACK

Note that every algorithm has one operator with a "feedback loop"-represented by a line from the output of the operator which feeds back to the input of the same operator. In effect, a feedback loop means that the operator is modulating itself. While every algorithm has one feedback loop, feedback is not necessarily used in every voice. One of the DX27 editing functions permits the feedback level to be set between 0 (no feedback) and 7 (maximum feedback).

ENVELOPE GENERATORS

Consider what happens when you play a note on an acoustic instrument. The level of the sound initially goes up to some value, then eventually falls to nothing, following a pattern that is characteristic of the particular instrument played. For example, a low note on a pipe organ starts slowly when you press a key, because it takes a while for the large column of air within the pipe to build up to maximum oscillation level, and takes a while to die down once the key is released. A note played on a wood block, on the other hand, starts quickly as the mallet strikes the block, and stops quickly as the block stops resonating. The characteristic volume pattern of any note played on any instrument is known as its "volume envelope." Most acoustic instruments also have a "timbre envelope," in which the harmonic

content of the note changes (the timbre changes) from the time the note is initiated to the time it decays.

Each of the 4 operators available in DX27 can be programmed with its own envelope. The envelope applied to a carrier will, generally, contribute to the overall volume envelope of the note, while an envelope applied to a modulator will contribute to the timbre envelope of the note.

Here is a copy of the envelope diagram printed to the right of the algorithm diagrams on the DX27 panel.

ENVELOPE GENERATOR

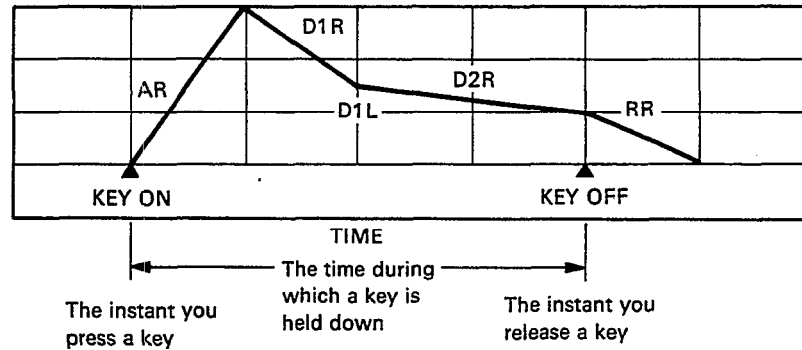

This envelope diagram can be used as a guide in visualizing DX27 envelope settings while you program or edit a voice.

Each envelope generator can be programmed with five different parameters: ATTACK RATE (AR), DECAY 1 RATE (D1R), DECAY 1 LEVEL (D1L), DECAY 2 RATE (D2R), and RELEASE RATE. The RATE parameters determine how fast the envelope moves from one level to the next. The term LEVEL is used rather than “volume” because the envelope of the operator you’re working on could affect volume or timbre, depending on whether it is a carrier or a modulator.

Any note begins at zero level when you press a key, then begins to approach maximum EG level at a rate determined by the AR (Attack Rate) setting. The envelope may reach maximum level instantly, or it may take over 9 seconds depending on the setting of AR.

When the envelope reaches maximum level, it immediately begins moving towards the next level in the envelope—D1L (Decay 1 Level)—at a speed determined by the setting of D1R (Decay 1 Rate).

The change from maximum EG level to D1R can be either a decrease in level or a sustain at maximum level, depending on the values you choose for D1L.

After reaching D1L, the envelope then begins to decay toward zero level at a speed determined by the setting of the D2R (Delay 2 Rate) parameter. If D2R is set to 0 (no decay), however, the note will be sustained at D1L for as long as you hold the key. Now, when you release the key you have been holding, the envelope will immediately begin to decay toward 0 level at a speed determined by RR (Release Rate). In fact, at whatever point in the envelope you release the key, the envelope will immediately begin moving toward 0 level at the set Release Rate. AR, D1R, and D2R settings of 0 produce sustain at initial level, while an RR setting of 0 produces a slow decay. Thus ends the note envelope “history.”

2. The EDIT and COMPARE Modes

To actually program or edit a voice, you need to enter the EDIT mode. This is done by pressing the EDIT/COMPARE button.



E1111 ALG= 5

When the EDIT mode is activated, the LCD will indicate the operator ON/OFF status (the group of four 1s or 0s), the currently selected voice parameter, and the currently selected operator. The latter in the series applies only to parameters that deal with individual operators. You will note, also, a capital letter “E” at the left side of the LCD. This indicates that you are in the EDIT mode, but that the voice has not yet been altered, i.e., it is an unedited voice. The last voice selected in the PLAY mode will be selected for editing. The individual voice parameters are then selected by pressing the corresponding voice buttons—all edit parameters are printed in purple above the voice buttons. The selected parameter is then programmed using the DATA ENTRY slider or -1/+1 buttons. The individual parameters will be described in detail below.

Once the EDIT mode has been called and a parameter change has been made, a small letter “e” will appear at the left side of the LCD, indicating that editing is in progress. You can play the DX27 keys and listen to how parameter changes are affecting the voice as you edit. In many cases, you will be editing an existing voice and will want to compare the sound of the edited voice with the original voice. This is done simply by pressing the EDIT/COMPARE button again. The small letter “e” at the left side of the LCD will change to a “C,” indicating that the COMPARE mode has been activated, and that the voice you will now hear is the original voice before editing (the parameters displayed on the LCD will also revert to those of the original voice). You can then return to the voice being edited by pressing the EDIT/COMPARE button again. This can be repeated as many times as needed during the editing process. The COMPARE mode can be entered from the EDIT or FUNCTION modes after at least one data change has been made to the original voice.

The EDIT/COMPARE mode can be exited by entering the FUNCTION mode, or by pressing INTERNAL PLAY and selecting another voice. Please note, that if you exit the EDIT COMPARE mode and then select a new voice, ANY DATA YOU HAVE EDITED WILL BE ERASED!!! This is because all editing is performed in a special edit buffer memory which is the same memory to which a voice is called when its button is pressed. Note that the presence of a small letter “p” at the left side of the LCD means the edited voice has not been stored and will be erased if you select a new voice. To save edited data, you must use the STORE function to save the new data in one of the DX27’s 24 INTERNAL voice memories. The STORE function will be discussed in this chapter. VOICE PROGRAMMING. If you do make a mistake and lose the edited data, the DX27 has been provided with a special temporary buffer memory from which the lost data can be recalled (assuming only one error has been made) using the RECALL EDIT function. The RECALL EDIT function was discussed in *CHAPTER III: MEMORY MANAGEMENT*.

3. The Voice Parameters

The following is a brief description of each available voice parameter, how it is programmed, and its effect. These parameters are selected by pressing the appropriately labelled (purple labels indicate voice parameters) button while the DX27 is in the EDIT mode.

PB MODE: OPERATOR SELECT

OPERATOR
SELECT
PB MODE
MODE SET

This switch (located immediately above the -1 DATA ENTRY button) selects the operator to be worked on. Only one operator can be selected at a time. Only the parameters for the selected operator will be displayed on the LCD panel.

In the EDIT mode, the currently selected operator number is displayed at the right side of the LCD: for example, "OP3." This only applies to parameters which can be individually programmed for each operator. However, when parameters that affect all operators simultaneously are called (the LFO WAVE, SPEED and DELAY parameters, for example), the current operator display will disappear from the LCD and individual operators cannot be selected.

BANK A—D/OPERATOR/AMS "ON-OFF"

OPERATOR/AMS ON-OFF		OPERATOR/AMS ON-OFF	
1	2	3	4
BANK A	BANK B	BANK C	BANK D
101 ~ 124	201 ~ 224	301 ~ 324	401 ~ 424
PRESET SEARCH		PRESET SEARCH	

Individually turns operators 1 through 4 ON or OFF. In many cases, a voice will not require all operators in an algorithm. Operators, that are not needed should be turned OFF while editing. Also, during the voice creation process, it is a good idea to start with all operators OFF and then turn them ON one at a time as you program and add them to the algorithm. The four digits immediately preceding the algorithm number on the LCD display represent the four operators, 1 through 4, in order from left to right. When an operator is ON, a "1" appears in the corresponding position, and when an operator is OFF a "0" appears in the corresponding position. Each press on the BANK A through D buttons alternately turns the corresponding operator ON and OFF.

When the AMPLITUDE MODULATION SENSITIVITY parameter is selected (10), these buttons are used to determine to which operators the sensitivity setting will apply.

When the EG COPY function is in use (see page 38), these buttons are used to select the operator to which the data from the currently selected operator will be copied.

1: ALGORITHM

ALGORITHM
1

Permits selection of any of the 8 available algorithms. The desired algorithm number is selected using either the DATA ENTRY slider, -1/+1 buttons, or the parameter button.

e1111 ALG= 6

2: FEEDBACK

FEEDBACK

2

Feedback can be applied to one operator in each algorithm. Pressing this button permits setting the amount (level) of feedback which will be applied.

The feedback level range is from 0 to 7. At 0, feedback is OFF, and at 7 maximum feedback is applied.

Data is entered via the DATA ENTRY slider or buttons.

e1111 FBL=4

The LFO

“LFO” stands for Low Frequency Oscillator. This oscillator is used to apply modulation effects such as tremolo or vibrato to the DX27 voices. By setting the LFO WAVE, SPEED, and SYNC parameters, you determine the effect that will be applied to the currently selected voice when the modulation wheel or breath controller is operated. The effect can also be applied without using the Wheel or Breath Controller by adjusting the AMD and PMD parameters. The LFO parameters work together with the MODULATION SENSITIVITY (9 and 10) parameters, and these must be set carefully to achieve the desired effect.

3: LFO WAVE

LFO

WAVE

3

Permits selection of the low frequency oscillator waveform. The available waveforms are SAW UP (a rising sawtooth waveform), SQUARE, TRIANGLE, and S/HOLD (sample and hold). When used in conjunction with LFO SPEED, DELAY, LFO PMD, and LFO AMD, a vast range of phase shifting and flanging-type effects can be obtained. And depending upon the depth of your individual settings for any particular voice, these effects could range from subtle, sympathetic coloration of a “piano” voice, or a “pipe organ” voice with an extremely broad low-frequency sweep.



These waveforms are selected using the DATA ENTRY slider or buttons.

e1111 LW=saw up

e1111 LW=square

e1111 LW=triangl

e1111 LW=S/hold

4: LFO SPEED

SPEED

4

Permits setting the speed of the low frequency oscillator. The data range is from 0 to 99.0 corresponds to the slowest LFO speed (0.0008 Hz), and 99 corresponds to the fastest LFO speed (55 Hz).

e1111 LFS=20

5: LFO DELAY

DELAY

Permits setting a delay of between 0 and approximately 10.7 seconds before the LFO modulation effect begins after a key is played. This is particularly useful for simulating brass instruments, human voice, etc., in which a vibrato effect is gradually applied after the note has been initiated.

The data range is from 0 to 99. At 0 there is no delay, and a setting of 99 produces an initial delay of approximately 10.7 seconds, which slowly increases over a period of 10.7 seconds. With longer delay settings the modulation effect begins gradually for a remarkably natural sound.

e1111 LFD=30

6: LFO PMD

PMD

This parameter sets the depth of pitch-variation simultaneously produced by LFO modulation for all operators. This function is independent from pitch modulation produced by the modulation wheel and breath controller, and is always ON once set.

The data range is from 0 to 99. At 0 pitch modulation is OFF, and a setting of 99 produces the greatest pitch variation, dependent on the PITCH MODULATION SENSITIVITY setting, described below (9). When the PITCH MODULATION SENSITIVITY parameter is set to maximum (7), the maximum pitch variation (PM DEPTH = 99) will be ± 800 cents.

Even if this parameter is set to 0, pitch modulation can still be applied via the modulation wheel or breath controller.

7: LFO AMD

AMD

This parameter sets the depth of amplitude variation (tremolo or wow) simultaneously produced by LFO modulation for all operators. This function is independent from amplitude modulation produced by the modulation wheel or breath controller, and is always ON once set.

The data range is from 0 to 99. At 0, amplitude modulation is OFF, and a setting of 99 produces the greatest variation, dependent on the AMPLITUDE MODULATION SENSITIVITY setting (10). When the AMPLITUDE MODULATION SENSITIVITY parameter is set to maximum (3), the maximum amplitude variation (AM DEPTH = 99) will be 96 dB peak-to-peak.

Even if this parameter is set to 0, amplitude modulation can still be applied via the modulation wheel and breath controller.

e1111 AMD=35

8: LFO SYNC

SYNC

The beginning of the LFO cycle is normally synchronized with key-on timing. This parameter permits turning this synchronization on or off. All operators are affected simultaneously.

When this parameter is on, the LFO cycle always begins from the peak of a positive half-cycle (90 degrees phase angle) when a key is played. This produces a clear, consistent attack on all notes.

When LFO KEY SYNC is OFF, the LFO cycle starts from a random point when a key is played. This is the ideal setting when the LFO is being used to create natural-sounding chorus or phasing-type effects.

9: PITCH MODULATION SENSITIVITY

MODULATION

PITCH

9

This parameter sets the sensitivity of all operators to pitch modulation applied either via the LFO PMD parameter, above, or via the modulation wheel or breath controller. The data range is from 0 to 7. At 0, no pitch modulation can be applied, and at 7 the maximum pitch modulation can be achieved. When LFO PMD, above, is set to 99, a setting of 7 produces a ± 800 cents pitch variation.

e1111 PMS= 6

10: AMPLITUDE MODULATION SENSITIVITY

SENSITIVITY

AMPLITUDE

10

This sets the operator's sensitivity to LFO effects applied via the LFO PMD or AMD functions, or via the modulation wheel or breath controller.

The application of LFO modulation to a carrier results in tremolo, and applied to a modulator the result is a periodic variation in timbre similar to wah effects. Applied to a modulator, the result is brilliance control.

The data range is from 0 to 3. At 0, amplitude modulation sensitivity is OFF and no LFO effects can be applied to the selected operators. A setting of 3 produces maximum sensitivity and therefore maximum effect depth.

The operators to which modulation sensitivity is to be applied are selected using buttons BANK A through BANK D. The four digits—1 or 0—at the right side of the LCD correspond to operators 1 through 4. When an operator is turned ON, i.e. able to receive amplitude modulation, the corresponding digit will be a "1." When OFF, the corresponding digit will be a "0." The operators are turned ON and OFF alternately each time the corresponding OPERATOR/AMS ON-OFF button is pressed.

e1111 AMS=3 0000

11: EG BIAS SENSITIVITY

EG BIAS

11

This sets the operator's sensitivity to EG BIAS effects applied via the breath controller. EG bias changes the overall output level from the operator. The harder you blow into the breath controller, the higher the maximum envelope level. When EG BIAS is applied to a carrier via the breath controller, the result is volume (expression) control. Applied to a modulator, the result is brilliance control.

The data range is from 0 to 7. At 0, EG BIAS sensitivity is OFF and no EG BIAS

effects can be applied to the selected operators. A setting of 7 produces maximum sensitivity and therefore maximum effect depth.

e1111 EBS= 7 OP3

12: KEY VELOCITY

KEY VELOCITY

12

While the DX27 has no key velocity sensitivity of its own, its voice generators will accept key velocity data from an external MIDI controller keyboard which does have this feature. This function determines the sensitivity of each operator to keyboard velocity sensitivity data from an external keyboard connected to the DX27 MIDI IN terminal (key velocity sensitivity = the harder you play a key, the louder the note. Timbre variations are produced when keyboard sensitivity is applied to a modulator).

The data range is from 0 to 7. At 0, key velocity sensitivity for the selected operator is OFF. A setting of 7 produces the highest sensitivity, and therefore the greatest effect. If KEY VELOCITY is set to other than 0, the volume produced when DX27 keys are pressed will decrease.

13: FREQUENCY RATIO

OSCILLATOR

FREQ RATIO

13

POLY/MONO

These parameters determine the actual frequency of each operator. For operators which function as carriers, this determines the actual pitch of the sound produced. For operators functioning as modulators, this determines the harmonic spectrum of the sound produced.

Each operator can be set to any of 64 different frequency ratios, as follows:

DX27 OPERATOR FREQUENCY RATIOS

0.50	0.71	0.78	0.87	1.00	1.41
1.57	1.73	2.00	2.82	3.00	3.14
3.46	4.00	4.24	4.71	5.00	5.19
5.65	6.00	6.28	6.92	7.00	7.07
7.85	8.00	8.48	8.65	9.00	9.42
9.89	10.00	10.38	10.99	11.00	11.30
12.00	12.11	12.56	12.72	13.00	13.84
14.00	14.10	14.13	15.00	15.55	15.57
15.70	16.96	17.27	17.30	18.37	18.84
19.03	19.78	20.41	20.76	21.20	21.98
22.49	23.55	24.22	25.95		

These frequency ratios have been carefully chosen as the most useful for voice programming. A ratio of 1.00 sets the selected operator to standard pitch—a pitch of 440 Hz will be produced when the A3 (A above middle C) key is pressed. A ratio of 0.50 produces a pitch one octave lower, and a ratio of 2.00 produces a pitch one octave higher than standard pitch, and so on. The fractional ratios—1.73, for example—produce extremely complex waveforms when combined with operators set to other ratios, permitting the creation of an unlimited variety of sound effects including extremely realistic bells, explosions, etc. Even ratios are useful for creating musical instrument sounds. It is possible to combine a modulator set to a fractional

ratio at a low operator level with even-ratio operators to add bite to a string sound and many other effects.
 The standard DX27 keyboard pitch is 8'; therefore, in terms of footage: 0.50 = 16', 1.00 = 8', and 2.00 = 4'.

14: DETUNE



This parameter permits slight detuning of the selected operator in relation to the others, making it possible to create richer, fuller voice effects. If detune is applied to carriers, the result is a thick, multi-instrument effect. Applied to modulators, the result is a slight periodic variation in timbre similar to a phase shift effect. The data range is from -3 to +3, for a maximum detuning range of +2.6 cents. At 0, no detune effect is produced.



15-19: ENVELOPE GENERATOR, AR, D1R, D1L, D2R, RR

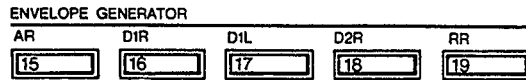

These buttons select the specific envelope generator parameters to be worked on: ATTACK RATE, DECAY 1 RATE, DECAY 1 LEVEL, DECAY 2 RATE, and RELEASE RATE.

The data range for AR, D1R, AND D2R parameters is 0 to 31, with 31 being the fastest rate (Instantaneous) and 0 the slowest (i.e. no change). The RR parameter has a data range of from 0 to 15, with 15 being fastest release and 0 being the slowest.

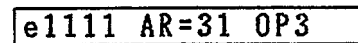

The following EG curve shows the relationship between the RATE and LEVEL parameters.

BASIC EG CURVE

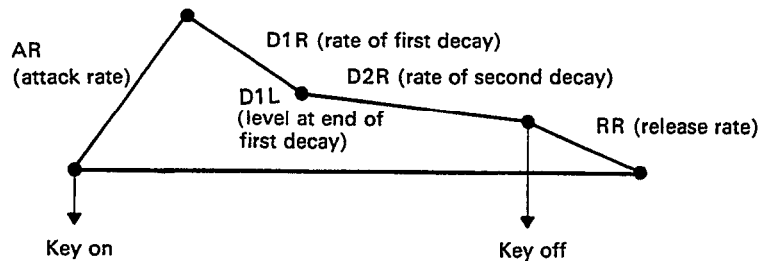

The following EG curves show the parameters for some common instruments.

PIANO E.G. CURVE

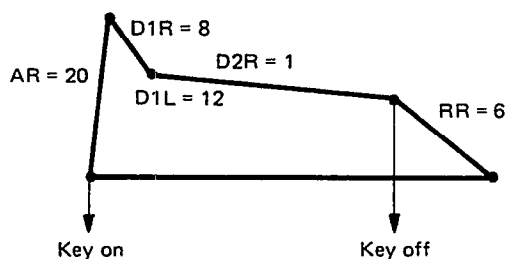

ORGAN E.G. CURVE

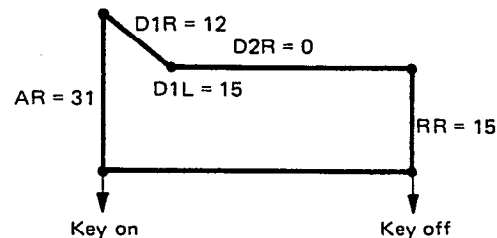

BRASS E.G. CURVE

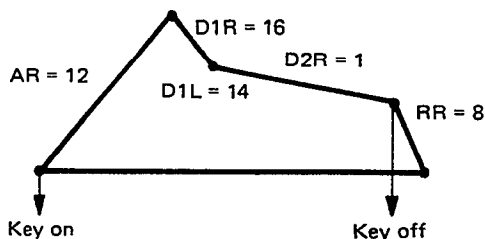

20: OPERATOR OUT LEVEL

OPERATOR
OUT LEVEL

Permits setting the output level of the selected operator. The data range is from 0 to 99. At 0, the operator is OFF. A setting of 99 produces maximum output level from the selected operator.

Varying the output level of an operator functioning as a carrier results in a change in the overall level of the sound contributed to the voice by that operator. Varying the output level of an operator functioning as a modulator results in a change in the harmonic spectrum produced by the carrier, thereby changing the timbre of the sound.

Data is entered using the DATA ENTRY slider or buttons.

21: RATE SCALING

KEYBOARD
RATE

This parameter makes it possible to gradually shorten the overall envelope length (increase EG rate) as higher notes on the keyboard are played. This is particularly useful for simulating the sound of stringed instruments such as piano or guitar, in which the envelope of the higher notes is noticeably shorter than the lower notes.

The data range is from 0 to 3. At 0 RATE SCALING is OFF, and at 3 the greatest variation in envelope length is produced.

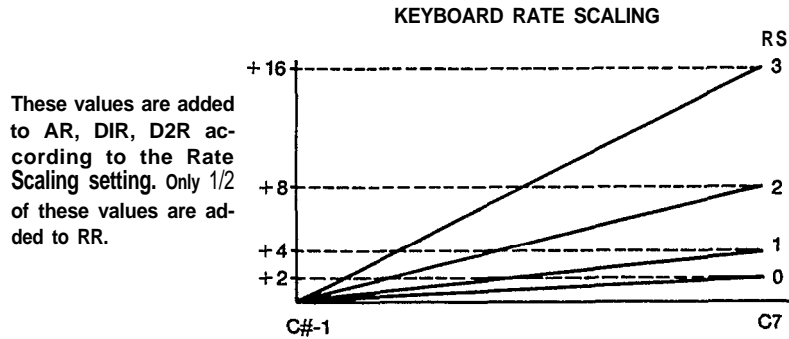

22: LEVEL SCALING

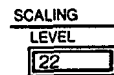

This parameter produces a gradual decrease in note output level towards the right (high) end of the keyboard. Many acoustic instruments exhibit a gradual decrease in level toward the higher notes, and this function can be used to create a natural overall keyboard response for any particular voice.

The data range is from 0 to 99. At 0, no level scaling is applied. At 99, the deepest keyboard level scaling effect is produced, and the highest note on the keyboard may be almost inaudible. Set this parameter for the most natural overall balance for the particular voice.

23: TRANSPOSE



This function permits transposing the pitch of the entire DX27 keyboard up or down two octaves in semitone steps.

The data range is from C1 to C5 (C3 is middle C, C2 is one octave lower than middle C, C4 is one octave higher than middle C, etc.). Immediately after this function is called, the desired new key can be selected simply by pressing any note on the keyboard between C1 and C5 (within a plus or minus two-octave range of middle C). The keyboard's C3 key then assumes the pitch of the key played, and all other keys are adjusted automatically. Pressing any key higher than C5 on the keyboard results in a transposition to C5. This method of data entry can only be used once, immediately after the TRANSPOSE function is called. Further alterations may be made using the DATA ENTRY control or -1/+1 switches.

EG COPY



EG COPY allows you to copy ENVELOPE GENERATOR parameters (AR, D1R, D1L, D2R, RR) and Keyboard Scaling (RATE, LEVEL) from one operator to another operator.

While in the EDIT mode, select a Source operator via the OPERATOR SELECT button at the far left of the DX27 panel. Next, press the EG COPY function button (this is the same as the STORE button). The LCD will respond with "EG Copy OP1 → OP?" You may then select a destination operator via the OPERATOR/AMS ON-OFF buttons. While holding down the EG COPY button, select a destination. Release, and repeat for any other operator destination you wish to copy into.

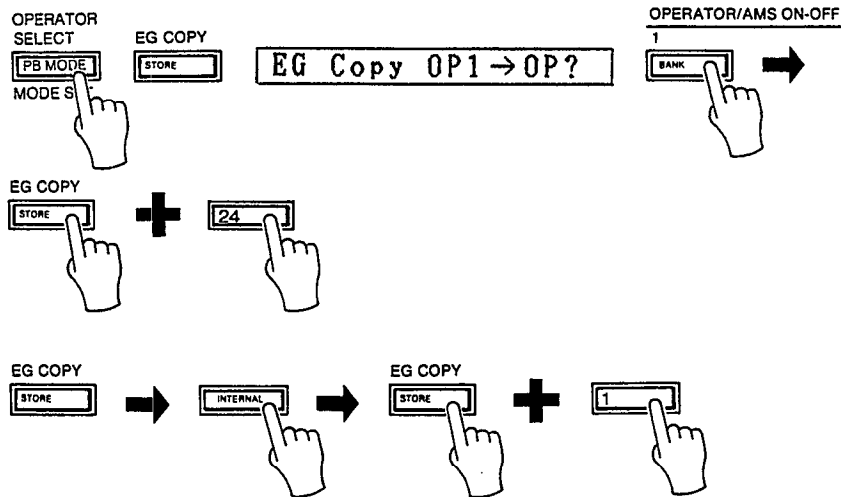

4. Storing Voice Data

If you have edited any of the above voice parameters and wish to store the new voice, you must use the STORE function BEFORE PRESSING ANY VOICE BUTTON AFTER EXITING THE EDIT OR FUNCTION MODES, and store the new data in one of the 24 INTERNAL memories. For this reason it is a good idea to have a free memory location ready before you begin editing. If you are editing and storing a voice to INTERNAL memory that was originally selected from PRESET memory, you can still recall the original PRESET memory voice at any time (PRESET memory will never change).

NOTE:

If the INTERENAL memory contains your own original voices, make sure that any voices you want to keep have been saved to cassette tape, so that they can be recalled later.

To STORE a newly edited voice, first exit the EDIT mode by pressing the PLAY mode button. Then, hold down the STORE button (this is the same as the EG COPY button) and press the voice button to which you want to save the edited voice data. The MEMORY PROTECT function must be OFF before attempting to use the STORE function.

Mem Store → ?

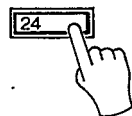

P1 Mono Sax

5. Two Approaches to Creating Your Own Voices

There are two basic approaches that can be taken when programming voices on the DX27. First, you can run through all the existing voices, choose one that is close to the sound you wish to create, and then edit that voice to create your own. Second, you can "initialize" the voice edit buffer (see *CHAPTER III: 5. MEMORY MANAGEMENT, 7. The Initialize Voice Function*), setting all parameters to their initial values, and begin programming your voice from scratch.

The first method, editing an existing voice, is generally a much more efficient approach. If, however, you are looking for a unique voice that is totally unlike any of the available presets, it is probably best to initialize and start from scratch.

If you choose to program a voice from scratch, you'll need to have a clear memory location (or one containing a voice that you either don't want or have already backed up on cassette tape, so that when you've completed programming the voice, you can save it). Since all editing is done in the separate voice edit buffer, nothing is erased while you are actually programming the voice. But when you save the new voice, whatever was in that memory location will be erased and replaced by the new data.

CHAPTER V: VOICE PROGRAMMING EXAMPLE

In this section we'll go through the steps in creating a fairly percussive electric piano voice from scratch. This simple example should help you understand the programming process.

STEP 1:

Initialize a Voice

Enter the FUNCTION mode (press FUNCTION button) and call the MEMORY PROTECT function. Turn MEMORY PROTECT OFF.



Call INIT VOICE function and press the YES button twice. This initializes the voice and automatically enters the EDIT mode. Select the ALGORITHM select parameter.

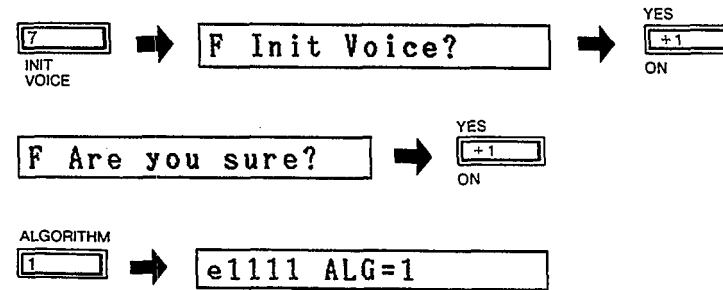

If you now play a note you will hear a sine wave.

STEP 2:

Selecting the Algorithm

In this voice there are two distinct sound components: the main piano decay sound and a percussive attack “ping.” For this purpose we'll use algorithm 5, which has two separate vertical “stacks” of two operators each. The ALGORITHM parameter has already been called, so select algorithm 5 using the DATA ENTRY controls.

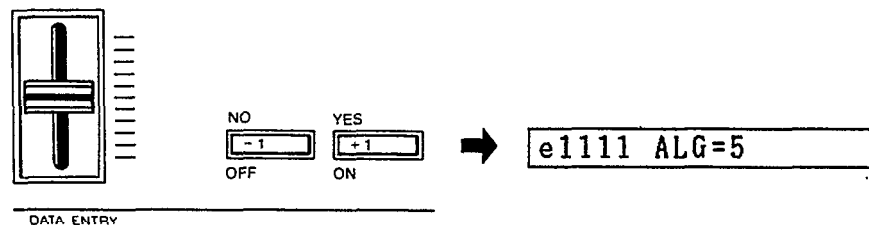

STEP 3:

Turn Operators 3 and 4 OFF

We'll start by programming the main piano sound using the left operator stack in algorithm five—operators 1 and 2. Turn operators 3 and 4 OFF using the corresponding OPERATOR/AMS ON-OFF buttons.

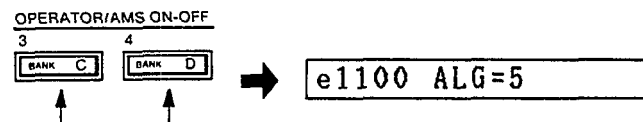

Since the voice has been initialized, the output level of operator 1 will be set at 90 and that of operator 2 will be 0, so at the moment we only hear the sound from operator 1.

STEP 4:

Set the OP1 (carrier) EG

Select the ENVELOPE GENERATOR AR parameter, and select operator 1 by pressing the OPERATOR SELECT button.

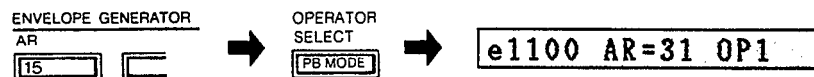

We want an instantaneous attack, so AR should be set at 31. Select the D1R parameter and set to 10 for a relatively slow initial decay.

Select the D1L parameter and set to 10.

Select the D2R parameter and set to 8.

Select the RR parameter and set to 8.

Now play a note and listen to the volume envelope we've created. This is the basic form of the electric piano voice.

STEP 5:

Copy OP1 (carrier) EG Parameters to OP2 (modulator)

Hold down the EG COPY button and press the OPERATOR/AMS ON-OFF 2 button.

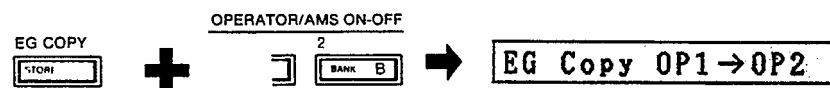

The EG parameters you just set for operator 1 have now been copied to operator 2. You can check this by selecting operator 2 (press OPERATOR SELECT) and looking at the EG parameters (AR—RR).

STEP 6:

Set OP1 and OP2 Output Levels

In this step we'll create the basic timbre of our piano voice.

First, select OP1, select the OPERATOR OUTPUT LEVEL parameter and set it to 99.

e1100 OUT=99 OP1

Next, select OP2 and set its output level to 66.

e1100 OUT=66 OP2

Play a key and note that we no longer have a simple sine wave. By increasing the output level of OP2 we are modulating the carrier, OP1, thereby creating a more complex waveform. In this case the frequency ratios of OP1 and OP2 are left at their initialized values of 1.00, since this is the basic timbre we want for this voice.

STEP 7.

Turn OFF OP1 and OP2, Turn ON OP3 and OP4

Now that we've created the basis for our piano voice, turn OP1 and OP2 OFF so we can concentrate on creating the attack sound using the remaining operator stack (OP3 and OP4). Now turn OP3 and OP4 ON.

e0011 OUT=0 OP3

STEP 8:**Set OP3 (carrier) EG**

Before we actually set the OP3 EG parameters, select OP3 using the OPERATOR SELECT button, call the OPERATOR OUTPUT LEVEL parameter and set it to 99. Now enter the following EG parameters:

AR = 31
DIR = 13
D1L = 0
D2R = 0
RR = 10

STEP 9:**Copy OP3 (carrier) EG Parameters to OP4 (modulator)**

Hold down the EG COPY button and press the OPERATOR/AMS ON-OFF 4 button.

EG Copy OP3 → OP4

STEP 10:**Raise OP4 (modulator) Output Level**

Select OP4, select the OPERATOR OUTPUT LEVEL parameter and set it to 71.

e0011 OUT=71 OP4

STEP 11:**Set OP4 Frequency Ratio**

To get a metallic attack “ping,” we’ll set the OP4 output level frequency ratio to 7.00. With OP4 selected, press the OSCILLATOR FREQ RATIO button and set to 7.00.

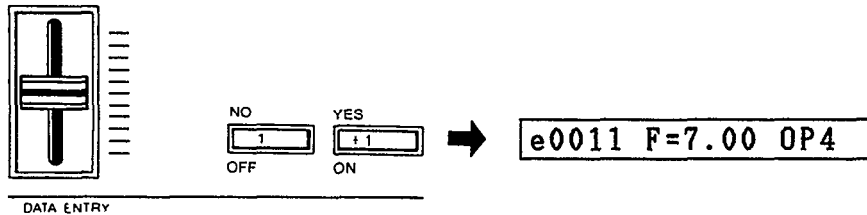

Play a note and listen to the attack sound.

STEP 12:**Combine all Operators and Balance Levels**

Turn OP1 and OP2 back on so we can here the combined sound of the two operator stacks. Play a note. At this point the attack sound is far too loud, so we’ll reduce the output level of OP3 to achieve a better balance.

Select OP3, press the OPERATOR OUTPUT LEVEL button and set to 70.

e1111 OUT=70 OP3

Play a note—our piano voice is improving.

STEP 13:**Set Feedback Level**

We can enhance the attack sound of the voice by adding just a touch of “bite” using feedback. Select the FEEDBACK parameter and set to 5.

e1111 FBL=5

STEP 14:***Set Keyboard Level Scaling***

Play a few notes or chords across the range of the keyboard. At this point the upper-range notes are a little too loud and tinny for proper overall keyboard balance. Select the KEYBOARD LEVEL SCALING PARAMETER, select OP1 and set to 20. Next, select OP2 and set to 30.

e1111 LS=30 OP2

Try the entire keyboard range again—much better overall balance.

STEP 15:***Add Amplitude Modulation to OP2***

As a final enhancement to our voice, let's add just a touch of amplitude modulation to OP2—the main piano sound modulator. This will create a subtle chorus effect.

Select the LFO WAVE parameter, set to triangle.

Select the LFO SPEED parameter, set to 28.

Select the AMD (Amplitude Modulation Depth) parameter, set to 52.

Select the MODULATION SENSITIVITY, AMPLITUDE parameter, set to 1 for OP2 only (press the OPERATOR/AMS ON-OFF button).

Now try the voice. That's it! Name the new voice, if you like, by entering the FUNCTION mode and using the VOICE NAME, function. The only step that remains is to store our new voice in an INTERNAL memory location.

STEP 16:***Store Completed Voice in INTERNAL memory***

Press the INTERNAL button, then BEFORE DOING ANYTHING ELSE: hold down the STORE button and press the voice selector to which you wish to store the new voice.

As a final precaution, go back to the FUNCTION mode and turn MEMORY PROTECT ON.

GENERAL SPECIFICATIONS

Keyboard	61 keys
Sound Source	FM Tone Generator (4 operators, 8 algorithms)
Simultaneous Note Output	8 notes, reverse priority
Internal Memory	24-voice INTERNAL memory (alterable) 192-voice PRESET memory (reading only) 96-voice number bank (alterable)
Effects	PITCH BEND, MODULATION, PORTAMENTO, SUSTAIN, KEY VELOCITY (reception only)
Controls	PITCH BEND WHEEL, MODULATION WHEEL, VOLUME
External Control Terminals	BREATH CONTROL, FOOT SWITCH
Connecting Terminals	OUTPUT (rated output level -20dB/output impedance 10K Ω or less), PHONES (rated output level -16dB/output impedance 47 Ω or less), FOOT SWITCH (PORTAMENTO ON-OFF/SUSTAIN ON-OFF), MIDI IN, MIDI OUT, MIDI THRU, CASSETTE (transmission speed 1,200 baud), BREATH CONTROL, DC IN
Power Supply	US & Canadian Model: 120V, 50/60Hz General Model: 220V, 50Hz
Dimensions (WxHxD)	909(W) x 82(H) x 270(D)mm (35.8" x 3.2" x 10.6")
Weight	7.5kg (16.5lbs)
Standard Accessories	Music Stand, AC Adapter PA-1210, Cassette Cable, Explanation Cassette Tape
Optional Accessories	FC-4/FC-5 Foot Switches, BC-1 Breath Controller

* Odb-0.775Vr.m.s.

* Specifications and appearance are subject to change without notice.

MIDI DATA FORMAT

1. Transmission Conditions

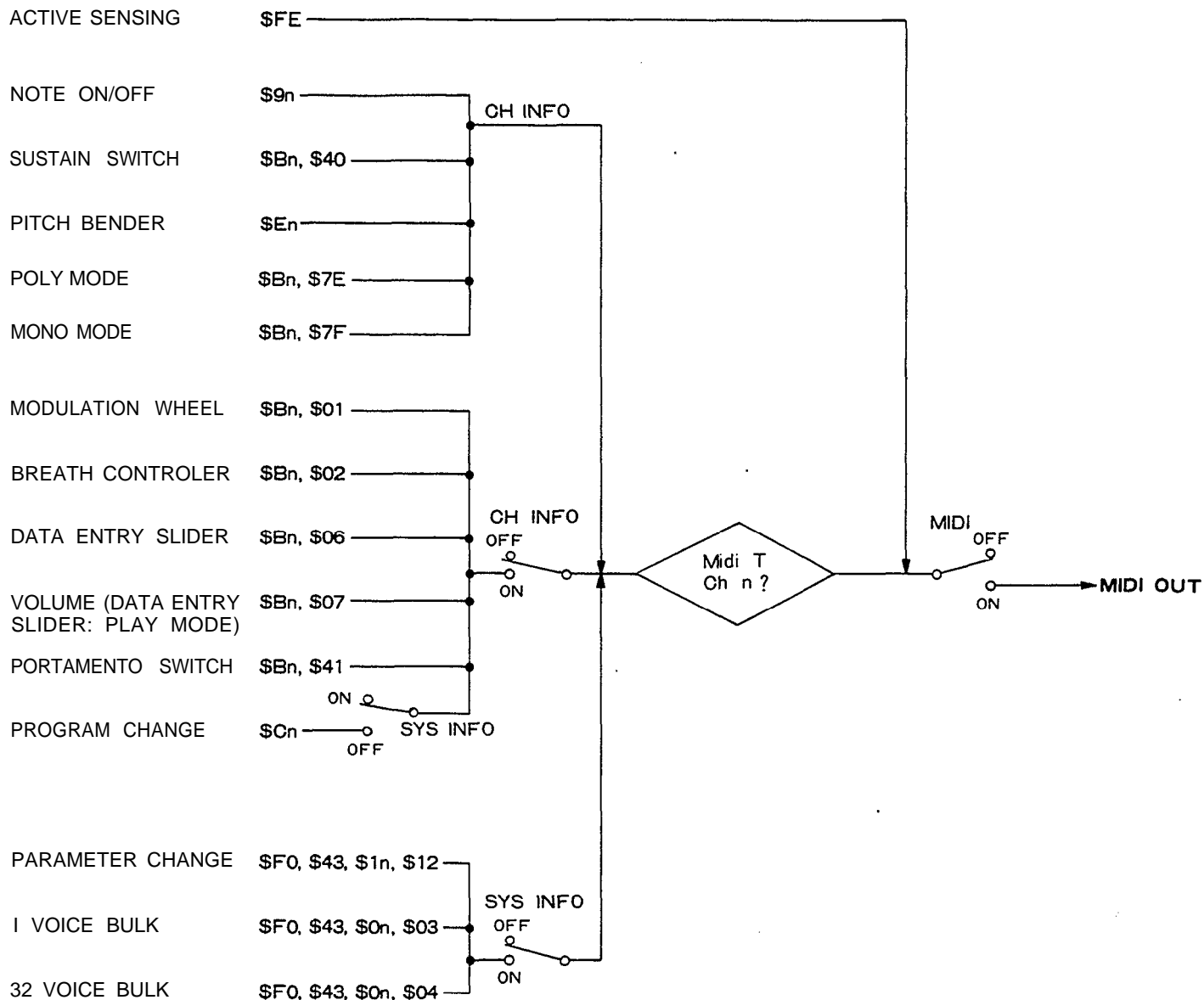

2. Transmission Data

All MIDI data is transmitted when the MIDI ON/OFF function is ON, The MIDI transmission channel is determined by the setting of the MIDI T CH function.

2-1. Channel Information

2-1-1 Channel Voice Message

(1) Key On/Off

Status	1001 nnnn(9n)	n=channel no.
Note. no.	0kkkkkkk	k=36(C1) ~ 96(C6)
Velocity	01000000(40)	Key on
	01000000(00)	Key off

(2) Control Change

Status	1011nnnn(Bn)	n=channel no.
Control no.	0ccccccc	
Control code	0vvvvvvvv	

a) Transmitted whether MIDI CH INFO is ON or OFF

Control no.	Control code.
C=64: Sustain sw.	V=0: OFF, 127: ON
C=126: POLY mode	
C=127: MONO mode	

b) Transmitted when MIDI CH INFO is ON

Control No.	Control code
C=1: modulation wheel	V=0 ~ 127
C=2: breath control	V=0 ~ 127
C=6: data entry slider	V=0 ~ 127
C=7: volume (data entry)	V=0 ~ 127
C=65: portamento sw.	V=0: OFF, 127: ON
C=96: data entry +1	
C=97: data entry -1	

(3) Program Change

Status	1100nnnn(Cn)	n=channel no.
Program no.	0ppppppp	p=0 ~ 23: INTERNAL p=24~119: BANK

This data is transmitted when a voice selector is pressed during the play mode, when MIDI CH INFO is ON and MIDI SYS INFO is OFF.

(4) Pitch Bend

Status	1110nnnn(En)	n=channel no.
Code (LSB)	0uuuuuuu	
Code (MSB)	0vvvvvvvv	

The transmitted data is as follows:

MSB	LSB	
00000000	00000000	Lowest value
01000000	00000000	Center value
01111111	01111110	Highest value

2-2 System Information

2-2-1 System Real-Time Message

Active sensing
Status 11111110(FE)

Transmitted once approximately every 200 milliseconds

2-2-2 System Exclusive Message

Transmitted only when MIDI SYS INFO is ON

(1) Parameter Change

Status 11110000(F0)
ID no. 01000011(43)
Substatus/ch. no. 0001nnnn(1n) n=channel no.
Parameter group no. 00010010(12)
Parameter no. 0ppppppp
Data 0ddddddd
EOX 11110111(F7)

This data is transmitted when voice or function Parameters are changed in the EDIT or FUNCTION modes. The voice parameters transmitted are those given in voice parameter table 5-2, and the function parameters transmitted are shown in function parameter table 5-3.

(2) 1 Voice Bulk Data

Status 11110000(F0)
ID no. 01000011(43)
Substatus/ch. no. 0000nnnn(0n) n=channel no.
Format no. 00000011(03)
Byte count 00000000(00)
Byte count 01011101 (5D)
Data 0ddddddd } 93 bytes
0ddddddd }
Checksum 0eeeeeee
EOX 11110111(F7)

The data for one voice is transmitted when a voice selector is pressed in the PLAY mode. Data in the voice edit buffer is transmitted when a format no. f=3 dump request is received. The transmitted data is shown in voice parameter table 5-2. The checksum is the lowest 7 bits of the two's complement sum of all data bytes (the same applies below).

Functions not available on this unit are set as follows:

CHORUS: 0
PEG PRI=99, PR2=99, PR3=99
PL1=50, PL2=50, PL3=50
FOOT VOLUME RANGE = 99

(3) 32 Voice BULK Data

Status 11110000(F0)
ID no. 01000011(43)
Substatus/ch. no. 0000nnnn(0n) n=channel no.
Format no. 00000100 (04)
Byte count 00100000 (20)

Byte count	00000000(00)	
Data	0ddddddd	} 4096 bytes
	0ddddddd	
Checksum	0eeeeeee	
EOX	11110111(F7)	

The data of 32 voices, including the 24 voices in RAM memory, will be transmitted if the YES key is pressed in response to the "MIDI Transmit?" display which appears when the SYS INFO key is pressed twice in the FUNCTION mode. The data for all 32 voices will also be transmitted when a format no. f=4 dump request is received. The transmitted data is shown in voice data table 5-1.55 bytes of 0's are added to the 73 bytes in this table, so 128 bytes are transmitted for each voice. 4096 bytes are therefore transmitted for all 32 voices. Voices 25 through 32 are transmitted with initialized voice parameters.

3. Reception Conditions

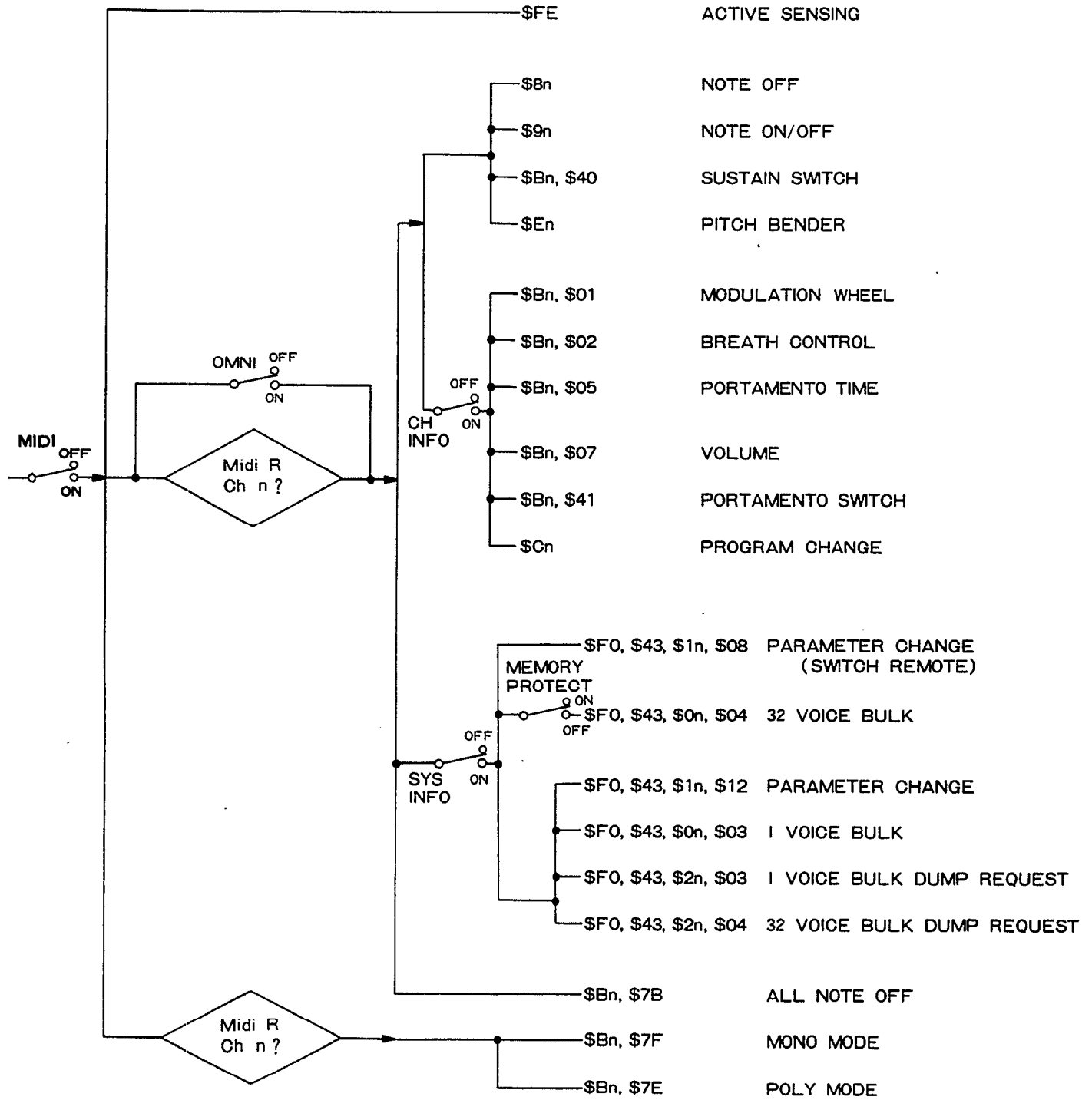

4. Reception Data

All MIDI data is received when the MIDI ON/OFF function is ON. When a specific MIDI receive channel has been selected using the MIDI R CH function, and the OMNI mode is OFF, MIDI data will be received only on the specified channel. MIDI data will be received on all channels when the OMNI mode is ON.

4-1. Channel information

4-1-1 Channel Voice Message

(1) Key Off

Status	1000nnnn(8n)	n=channel no.
Note no.	0kkkkkkk	k=0(C-2)~127(G8)
Velocity	00000000(00)	

(2) Key On/Off

Status	1001nnnn(9n)	n=channel no.
Note no.	0kkkkkkk	k=0(C-2) ~ 127(G8)
Velocity	0vvvvvvv	v=0: key off v=1~ 127: key on

The key on note level will vary according to the received velocity value (only when the KEY VELOCITY setting is greater than 0). The range of this instrument is C#-1 to C7. If a higher or lower key number is received, it will be output within the range limits. For example, received C#7 through C8 data will be output as notes in the C#6 through C7 range.

(3) Control Change

Status	1011nnnn(Bn)	n=channel no.
Control no.	0ccccccc	
Control code	0vvvvvvv	

a) Received whether MIDI CH INFO is ON or OFF

Control no.	Control code.
C=64: Sustain sw.	V=0~126: OFF, 127: ON

b) Received when MIDI CH INFO is ON

Control no.	Control code.
C=1: modulation wheel	V=0~127
C=2: breath control	V=0~127
C=5: portamento time	V=0~127
C=7: volume	V=0~127
C=65: portamento sw.	V=0 ~126: OFF, 127: ON

(4) Program Change

Status	1100nnnn(Cn)	n=channel no.
Program no.	0ppppppp	

Received only in the PLAY mode when MIDI CH INFO is ON. Number 120 through 127 will be processed as 119.

(5) Pitch Bend

Status	1110nnnn	n=channel no.
Code(LSB)	0uuuuuuu	
Code(MSB)	0vvvvvvv	

Functions only on MSB data:

MSB	
00000000	Lowest value
01000000	Center value
01111111	Highest value

4-1-2 Channel Mode Message

Status	1011nnnn	n=channel no.
	0ccccccc	
	0vvvvvvvv	

Received whether MIDI CH INFO is ON or OFF

C=123	V=0	All notes OFF
C=126	V=1	MONO mode ON
C=127	V=0	POLY mode ON

4-2 System information

4-2-1 System Real-Time Message

Active sensing	
Status	11111110(FE)

Sensing begins when this code is received once. If status and data are not received within 300 milliseconds the MIDI receive buffer will be cleared and the currently output note will be turned OFF.

4-2-2 System Exclusive Message

(1) Parameter Change (switch remote)

Status	11110000(F0)	
ID no.	01000011(43)	
Substatus/ch. no.	0001nnnn(1n)	n=channel no.
Parameter group no.	00001000(08)	
Switch no.	0mmmmmmm	
Data	0ddddddd	d=0: OFF, 1~127: ON
EOX	11110111(F7)	

All panel switches are controlled. The switch numbers are arranged as shown in the illustration below. Received when MIDI SYS INFO is ON.

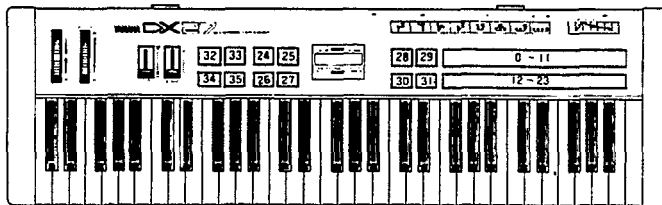

(2) Parameter Change

The format is the same as the transmitted parameter change data. Received only when MIDI SYS INFO is ON. Permits changing voice and function parameters while the EDIT mode is active. It is also possible to change modes: PLAY, EDIT, etc. The parameter no. and data received are show in voice parameter table 5-2 and function parameter table 5-3.

(3) 1 Voice Bulk Data

Received only when MIDI SYS INFO is ON. The format is the same as for the transmitted 1 voice bulk data. The 93 voice data bytes are read into the voice edit buffer, replacing the current voice data. The 93 received data bytes are shown in voice parameter table 5-2.

CHORUS, FOOT VOLUME RANGE and PEG data are ignored.

(4) 32 Voice Bulk Data

Received only when MIDI SYS INFO is ON. The format is the same as for the transmitted 32 voice bulk data. This data can be received only when the MEMORY PROTECT function is OFF. The received voice data is stored in the 24 INTERNAL voice memory locations. Voices numbered 25 and higher will be ignored. The "MIDI RECEIVED!!" display appears to confirm complete reception of voice bulk data.

(5) Dump Request

Status	11110000(Fn)
ID no.	01000011(43)
Substatus/ch. no.	0010nnnn(2n) n=channel no.
Format no.	0 f f f f f f f f f =3,4
EOX	11110111(F7)

Received only when MIDI SYS INFO is ON. When received the bulk data corresponding to the received format code will be dumped via MIDI OUT.

f=3: 1 voice bulk data
f=4: 32 voice bulk data

**5. System Exclusive
Data**

5-1. VOICE DATA (VMEM format)

Parameter no.	Parameter
P	
0	ATTACK RATE
1	DECAY 1 RATE
2	DECAY 2 RATE
3	RELEASE RATE
4	DECAY 1 LEVEL
5	KEYBOARD SCALING LEVEL
6	AMPLITUDE MODULATION ENABLE/EG BIAS
7	SENSITIVITY/KEY VELOCITY
8	OUTPUT LEVEL
9	OSCILLATOR FREQUENCY
	KEYBOARD SCALING RATE/DETUNE
10	
1	SAME AS FOR OP4
19	
20	
∫	SAME AS FOR OP4
29	
30	
∫	SAME AS FOR OP4
39	
40	LFO SYNC/FEEDBACK LEVEL/ALGORITHM
41	LFO SPEED
42	LFO DELAY
43	PITCH MODULATION DEPTH
44	AMPLITUDE MODULATION DEPTH
45	PITCH MODULATION SENSITIVITY/AMPLITUDE MODULATION SENSITIVITY/LFO WAVE
46	TRANSPOSE
47	PITCH BEND RANGE
48	CHORUS SWITCH*/PLAY MODE/SUSTAIN FOOT SWITCH/ PORTAMENTO FOOT SWITCH/PORTAMENTO MODE
49	PORTAMENTO TIME
50	FOOT VOLUME RANGE *
51	MODULATION WHEEL PITCH MODULATION RANGE
52	MODULATION WHEEL AMPLITUDE MODULATION RANGE
53	BREATH CONTROL PITCH MODULATION RANGE
54	BREATH CONTROL AMPLITUDE MODULATION RANGE
55	BREATH CONTROL PITCH BIAS RANGE
56	BREATH CONTROL EG BIAS RANGE
57	VOICE NAME 1
∫	∫
66	VOICE NAME 10
67	PITCH EG RATE 1 *
68	2 *
69	3 *
70	LEVEL 1 *
71	2 *
72	3 *

*:not used

5-2. VOICE PARAMETERS (VCED format)

parameter no. P	parameter	LCD Display	Data	Note	
0	ATTACK RATE	AR	0 ~ 31	}	
1	DECAY 1 RATE	D1R	0 ~ 31		
2	DECAY 2 RATE	D2R	0 ~ 31		
3	RELEASE RATE	RR	0 ~ 15		
4	DECAY 1 LEVEL	D1L	0 ~ 15		
5	KEYBOARD SCALING LEVEL	LS	0 ~ 99		
6	KEYBOARD SCALING RATE	RS	0 ~ 3		
7	EG BIAS SENSITIVITY	EBS	0 ~ 7		
8	AMPLITUDE MODULATION ENABLE		0 ~ 1		
9	KEY VELOCITY	KVS	0 ~ 7		
10	OUTPUT LEVEL	OUT	0 ~ 99		
11	OSCILLATOR FREQUENCY	F	0 ~ 63		} Center = 3
12	DETUNE	DET	0 ~ 6		
13 }	SAME AS FOR OP4			}	
25		OP2			
26 }	SAME AS FOR OP4				
38		OP3		}	
39 }	SAME AS FOR OP4				
51		OP1			
52	ALGORITHM	ALG	0 ~ 7	}	
53	FEEDBACK LEVEL	FBL	0 ~ 7		
54	LFO SPEED	LFS	0 ~ 99		
55	LFO DELAY	LFD	0 ~ 99		
56	PITCH MODULATION DEPTH	PMD	0 ~ 99		
57	AMPLITUDE MODULATION DEPTH	AMD	0 ~ 99		
58	LFO SYNC	SYNC	0, 1		
59	LFO WAVE	LW	0 ~ 3		
60	PITCH MODULATION SENSITIVITY	PMS	0 ~ 7		
61	AMPLITUDE MODULATION SENSITIVITY	AMS	0 ~ 7		
62	TRANSPOSE	MID. C	0 ~ 48		
63	PLAY MODE POLY/MONO	Poly Mode	0, 1		
64	PITCH BEND RANGE	P Bend Range	0 ~ 12		
65	PORTAMENTO MODE	Full T. Porta	0, 1		
66	PORTAMENTO TIME	Porta Time	0 ~ 99		
67	TRANSPOSE		0 ~ 48		
68	FOOT VOLUME RANGE	Foot Sw	0, 1		} Pair
69	SUSTAIN FOOT SWITCH	Foot Sw	0, 1		
70	PORTAMENT FOOT SWITCH				} *
71	CHORUS SWITCH				
72	MODULATION WHEEL PITCH MODULATION RANGE	MW Pitch	0 ~ 99		
73	MODULATION WHEEL AMPLITUDE MODULATION RANGE	MW Ampli	0 ~ 99		
74	BREATH CONTROL PITCH MODULATION RANGE	BC Pitch	0 ~ 99		
75	BREATH CONTROL AMPLITUDE MODULATION RANGE	BC Ampli	0 ~ 99		
76	BREATH CONTROL PITCH BIAS RANGE	BC P Bias	0 ~ 99		
77	BREATH CONTROL EG BIAS RANGE	BC E Bias	0 ~ 99		
78	VOICE NAME 1		32 ~ 127 (ASCII)		
79	}				} *
86	VOICE NAME 10				
87	PITCH EG RATE 1				
88	2				
89	3				
90	LEVEL 1			} *	
91	2				
92	3				

*: not used

5-3. FUNCTION PARAMETERS

Parameter no. P	Parameter	LCD Display	Data	Note
93	OPERATOR ENABLE/DISABLE		0, 1	
94	OPETATOR SELECT		0~ 3	
95	EDIT MODE 1 = ON	E. e	0, 1	*
96	FUNCTION MODE 1 = ON	F. f	0, 1	*
97	STORE MODE 1 = ON	Mem Store	0, 1	*
98				*
99				*
100	PLAY MODE 1 = ON	P. p	0, 1	*
101				
102				
103	MASTER TUNE 64 = CENTER	M. Tune	0 ~ 127	*
104	MIDI SWITCH 1 = ON	Midi :	0, 1	*
105	MIDI CH INFO	Ch.Info :	0, 1	*
106	OMNI 0=OFF 1=ON	Omni :	0, 1	*
107	MIDI TRANS CH	Midi T Ch	0 ~ 15	*
108	MIDI RECV CH	Midi R Ch	0 ~ 15	*
109	MIDI SYS INFO	Midi Sys.Info	0, 1	*
110	32 VOICE BULK DUMP	Midi Transmit ?	1	*
111	RECALL EDIT	Recall Edit ?	0, 1	*
112	INIT VOICE	Init Voice ?	0, 1	*
113	SAVE	Save to Tape ?	0, 1	*
114	VERIFY	Verify Tape ?	0, 1	*
115	LOAD	Load Tape?	0, 1	*
116	LOAD SINGLE	Load Single ?	0 ~ 127	*
117				
118				
119	MEMORY PROTECT 1=ON	M . Protect	0, 1	*
120	KEY SHIFT 24=CENTER	Key Shift	0~ 48	*
121	PITCH BEND MODE 1=ON	Bend Mode	0, 1	*
122	KEY SHIFT	K	0, 1	*
123	COMPARE	C	0, 1	*
124	PITCH BEND MODE		0, 2	*
125	PRESET SEARCH No.		0~ 95	*
126	BANK VOICE No.		0 ~ 95	*
127	BANK VOICE DATA		0 ~ 119	*

* Receive only

Function ...	Transmitted	Recognized	Remarks
Basic Default	1 - 16	1 - 16	memorized
Channel Changed	1 - 16	1 - 16	
Mode Default Messages Altered	3 - x *****	1, 2, 3, 4 POLY, MONO(M=1) x	memorized
Note Number : True voice	36 - 96 *****	0 - 127 13 - 108	
Velocity Note ON Note OFF	x 9nH, v=64 x 9nH, v=0	o v=1-127 x	
After Touch	Key's Ch's	x x	
Pitch Bender	o	o 0-12 semi	7 bit resolution
Control Change	1 : o 2 : o 5 : x 6 : o 7 : o 7 : 64 : o 65 : o 96 : o 97 : o	*1 : o *1 : o *1 : o *1 : x *1 : o *1 : o *1 : o *1 : x *1 : x	*1 : Modulation wheel *1 : Breath control *1 : Portamento time Data entry knob Data entry knob in play mode *1 : Volume Sustain foot sw *1 : Portamento ± sw Data entry +1 Data entry -1
Prog Change : True #	o .0 - 119 *3 *****	o 0 - 127 *1 0 - 119	
System Exclusive	o	*2 : o	*2 : Voice parameters
System Common	Song Pos : x Song Sel : x Tune : x	x x x	
System Real Time	:Clock : x :Commands : x	x x	
Aux Messages	:Local ON/OFF : x :All Notes OFF : x :Active Sense : o :Reset : x	x o (123,126,127) o x	
Notes: All MIDI communications are enabled if MIDI switch is on. *1 = transmit/receive if CH information switch is on. *2 = transmit/receive if system information switch is on. *3 = transmit if CH information switch is on and system information switch is off.			
Mode 1	OMNI ON, POLY	Mode 2	OMNI ON, MONO
Mode 3	OMNI OFF, POLY	Mode 4	OMNI OFF, MONO
			o : Yes x : No

YAMAHA VOICE/FUNCTION DATA

DATA NAME : _____

DATE : _____

NUMBER : _____

PROGRAMMER : _____

											AME	OP	
												4	
												3	
												2	
												1	
ALGORITHM	FEEDBACK	WAVE	SPEED	DELAY	PMD	AMD	SYNC	PITCH	AMPLITUDE	EG BIAS	KEY VELOCITY		
		LFO										MODULATION SENSITIVITY	
1	2	3	4	5	6	7	8	9	10	11	12		

OP												
4												
3												
2												
1												
FREQ RATIO	DETUNE	AR	D1R	D1L	D2R	RR	OUT LEVEL	RATE	LEVEL			
OSCILLATOR		ENVELOPE GENERATOR				OPERATOR		KEYBOARD SCALING				
13	14	15	16	17	18	19	20	21	22	23	24	
POLY/MONO	PITCH BEND RANGE	PORTAMENTO MODE TIME		FOOT SW ASSIGN	WHEEL RANGE PITCH AMPLITUDE		BREATH RANGE PITCH AMPLITUDE PITCH BIAS EG BIAS					

DATA NAME

DATE : _____

PROGRAMMER : _____

No.	VOICE NAME	REMARKS
1		
2		
3		
4		
5		
6		
7		
8		
9		
10		
11		
12		
13		
14		
15		
16		
17		
18		
19		
20		
21		
22		
23		
24		

DATA NAME

DATE:

PROGRAMMER :

A			B		
No.	VOICE NAME	REMARKS	No.	VOICE NAME	REMARKS
1			1		
2			2		
3			3		
4			4		
5			5		
6			6		
7			7		
8			8		
9			9		
10			10		
11			11		
12			12		
13			13		
14			14		
15			15		
16			16		
17			17		
18			18		
19			19		
20			20		
21			21		
22			22		
23			23		
24			24		

C			D		
No.	VOICE NAME	REMARKS	No.	VOICE NAME	REMARKS
1			1		
2			2		
3			3		
4			4		
5			5		
6			6		
7			7		
8			8		
9			9		
10			10		
11			11		
12			12		
13			13		
14			14		
15			15		
1 6			1 6		
17			17		
18			18		
19			19		
20			20		
21			21		
22			22		
23			23		
24			24		

FCC INFORMATION (USA)

While the following statements are provided to comply with FCC Regulations in the United States, the corrective measures listed below are applicable worldwide.

This series of Yamaha professional music equipment uses frequencies that appear in the radio frequency range and if installed in the immediate proximity of some types of audio or video devices (within three meters), interference may occur.

This series of Yamaha professional music equipment has been type tested and found to comply with the specifications set for a class B computing device in accordance with those specifications listed in subpart J of part 15 of the FCC rules. Those rules are designed to provide a reasonable measure of protection against such interference.

However, this does not guarantee that interference will not occur. If your professional music equipment should be suspected of causing interference with other electronic devices, verification can be made by turning your professional music equipment off and on. If the interference continues when your equipment is off, the equipment is not the source of interference. If your equipment does appear to be the source of the interference, you should try to correct the situation by using one or more of the following measures:

Relocate either the equipment or the electronic device that is being affected by the interference.

Utilize power for the professional music equipment and the device being affected that are on different branch (circuit breaker or fuse) circuits, or install AC line filters.

In the case of radio or TV interference, relocate the antenna or, if the antenna lead-in is 300 ohm ribbon lead, change the lead-in to co-axial type cable.

If these corrective measures do not produce satisfactory results, please contact your authorized Yamaha professional products dealer for suggestions and/or corrective measures. If you can not locate a authorized Yamaha professional products dealer in your general area contact the professional music Service Department, Yamaha International, 6600 Orangethorpe Ave., Buena park, CA90620, USA.

If for any reason, you should need additional information relating to radio or TV interference, you may find a booklet prepared by the Federal Communications Commission helpful; "How to Identify and Resolve Radio-TV Interference Problems". This booklet is available from the U.S. Government Printing Office, Washington D.C.

20402—Stock No. 004-000-00345-4.



DX27 OM
9/20/98 198001

YAMAHA[®]

Yamaha Corporation of America
6600 Orangethorpe Avenue, P.O. Box 6600, Buena Park, CA 90622-6600

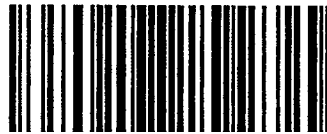

DX27 OM



Recyclable



Recycled